

Surveying, Excavating and Raising
THE MARY ROSE



Acoustic positioning survey operations associated with the wreck of
The Mary Rose: 1975 to 2005

Nigel C. Kelland and Peter Holt

Surveying, Excavating and Raising
The *Mary Rose*

Surveying, Excavating and Raising
THE MARY ROSE

Acoustic positioning survey operations associated with
the wreck of The *Mary Rose* : 1975 to 2005

Nigel C. Kelland and Peter Holt

Published in 2014 by Sonardyne International Ltd,
www.sonardyne.com

Copyright © Sonardyne Ltd, 2014
Copyright text © Nigel C. Kelland and Peter Holt, 2014

The rights of Nigel C. Kelland and Peter Holt to be identified as the authors of this book are asserted in accordance with the Copyright, Patents and Designs Act 1988.

The print publication is protected by copyright. Prior to any prohibited reproduction, storage in a retrieval system, distribution or transmission in any form or by any means, electronic, mechanical, recording or otherwise, permission should be obtained from the publisher.

Designed and typeset in Adobe Minion 11/15pt
by Michael Lindley www.truthstudio.co.uk

Printed and bound in the UK by Northend Creative
Print Solutions.

SONARDYNE.COM



Contents

	Foreword	1
1	Introduction	5
2	Side-Scan Sonar Survey – 1975	8
3	Rangemeter Survey of the <i>Mary Rose</i> – 1975	11
4	LBL Acoustic Surveys of the <i>Mary Rose</i> – 1979	21
5	Recovery of the <i>Mary Rose</i> Hull – 1982	24
6	Absolute Positioning – 1996	29
7	Site Excavation 2003 – 2005	31
8	Reassessing the Bow	42
9	Discussion of Survey Results	48
10	How would it be done today?	50
	<i>Acknowledgements</i>	56
	<i>References</i>	57
	<i>Glossary</i>	58

Figure 1: Artist's impression of Henry VIII's Mary Rose, 1545. (Geoff Hunt PPRSMA)



Foreword

DOGGED DETERMINATION, embracing new technology and using it to solve archaeological problems, has been a trademark of the individuals responsible for finding, excavating, and raising the *Mary Rose*. The relationship between acoustic survey and the *Mary Rose* began in the mid-seventies. Margaret Rule, the project archaeologist, attended a conference in Sweden which included a paper by Nigel Kelland on charting the movements of sand waves using a Rangemeter made by John Partridge of Sonardyne International. Margaret saw a potential application for precisely plotting the port frames of the *Mary Rose*, and by the end of the conference her determination and Nigel's enthusiasm ensured the future of acoustic positioning for underwater archaeological sites in Britain.

Right product, right place, right time and right people have also been a trademark of the *Mary Rose* story. The Prince of Wales, who had by this time dived on the site, suggested to the Chairman of British Petroleum that they support the *Mary Rose* Project using suitable North Sea technology. By this time Nigel Kelland was working for the BP Research Centre and had just completed a diving survey on the West Sole pipeline in the North Sea using the Rangemeter.

An obvious choice for the *Mary Rose*, Nigel completed his acoustic survey of the port side frames in October 1975, in tandem with a BP-sponsored side-scan sonar survey. This combination of Company sponsorship of equipment and staff was vital to the success of the *Mary Rose* Project, and BP became one of the first, largest and most enduring corporate sponsors. Further surveys relied on Sonardyne sponsoring both equipment and often staff, and they too rank as one of our most long-serving sponsors. The project marked the beginning of marriage of acoustic positioning, remote sensing and divers on the seabed on underwater archaeological sites.

One of the most tangential, exacting and demanding applications of acoustics was in the underwater transfer of the ship hanging under its lifting frame to the cradle placed on the seabed next to the wreck in 1982. The ship was literally 'conned' into the awaiting cradle; a first for underwater archaeology at the time.

Another first was the application of acoustics and GPS to accurately plot the erosion markers placed around the hole left in the seabed after the ship was raised. This marked the beginning of accurate position fixing of underwater archaeological sites in the UK, and in 1996 the *Mary Rose* crater was absolutely

positioned. The latter marked the beginning of another important association, the second author, Peter Holt, an employee of Sonardyne, borrowed the equipment and undertook the survey as a member of Plymouth Maritime Archaeological Interest Group. This liaison heralded a number of unique and often experimental applications of acoustics to underwater archaeological sites.

Another milestone was the reverse engineering of the surveyed hull back into the seabed by Peter Holt in 2002, again using equipment sponsored by Sonardyne. Potential deepening of the channel into the harbour to accommodate the new aircraft carriers meant that the area of the seabed around the *Mary Rose* site was under direct threat, and as part of the mitigation strategy the excavation of a percentage of the linear spoil mounds, site survey and retrieval of reburied timbers was funded by the MOD. In order to relate objects found in the spoil or around the site to the actual ship (and then to the rest of the artefacts raised between 1979 and 1982) we needed to place the surveyed hull in its original position. As the majority of the survey points were on the structure itself (lifted with the ship) this also required lateral thinking. Referring to Nigel Kelland's archive, Peter Holt found that a series of measurements on the hull had been taken to corners of a sunken dive platform just east of the site, by chance, still in situ.

In 2003, yet another first was the use of a crawling excavator fitted with an airlift, air jet, cameras and transceiver connected to two acoustic transducers on the airlift. This enabled the artefacts excavated from

within the spoil to be positioned relative to the original structure of the ship. Simultaneously, divers working around the site carried a survey staff fitted with a lightweight transceiver to accurately position artefacts and timbers. All of this was tied into the multi-beam, parametric sub-bottom profiler and magnetometer surveys undertaken between 2003 and 2005.

Acoustics were again used in 2004 to position a grid in a predetermined position to the north of the crater to include the stem and search for the starboard bow castle. In addition, control points on the corners of the fixed grid were used to position objects found within it. As with the original lift in 1982, in 2005 acoustics were used to transfer the stem onto its cradle and to lift it to the surface. The structure that was revealed and reburied during this excavation will continue to provide a challenge for archaeologists and surveyors. They will take for granted the tools, techniques and applications gained on the site of the *Mary Rose*, and their primary tool will be acoustics.



John Lippiett. Chief Executive
Mary Rose Trust
2003–present

1 Introduction

1.1 Underwater Acoustic Survey

In 1975 the wreck of King Henry VIII's great warship, the carrack *Mary Rose*, lay buried beneath the seabed in 12 metres of water some 2.5 kilometres south of the entrance to Portsmouth Harbour, England. The modern search for the *Mary Rose* began in 1966. Led by naval historian Alexander McKee, it was part of a diving project to locate wrecks of historic importance in the Solent area (McKee, 1973⁽¹⁾). A buried anomaly, thought to be the *Mary Rose*, was located in 1967 by using a dual channel side-scan sonar and sub-bottom profiler. As a result the Mary Rose (1967) Committee was formed with the aims of finding, excavating and raising the ship and her contents (Rule, 1983⁽²⁾). In 1968 a lease to the seabed where the anomaly lay was obtained from the Crown Estates. Further remote sensing was carried out in 1968 by Edgerton using two of the most up to date systems, including a 5kHz sub-bottom profiler. Although these again revealed a buried anomaly, a trench cut over this using water jets was inconclusive. In 1970 the barrel of a wrought iron gun was found by diver searches, and in 1971 a continuous line of timber frames with associated planking was seen. These were later confirmed as the port side frames of the *Mary Rose*. Targeted small excavations were carried out to investigate these frames and by 1975 there was enough articulated structure to confirm that a substantial portion of the starboard side of the ship was buried up to 5 metres below the seabed.

Following its rediscovery considerable effort had been expended by members of the Mary Rose (1967) Committee to assess the feasibility of salvage. As the silt of the seabed now completely covered the wreck, this entailed preparation of a plan of wooden frames and planking now

This Review outlines the Long BaseLine and Ultra Short BaseLine underwater acoustic positioning survey techniques used over thirty years to assist with the mapping and recovery of the wreck of the *Mary Rose* from 1975 to 1982, absolute positioning of the wreck site in 1996 and the site excavation work from 2003 to 2005. The equipment used in each case is described and the results discussed.

exposed at the seabed level and excavation of the seabed to study the vessel sides. In August 1975 when the author first became involved with the *Mary Rose*, the British Petroleum Company Limited (BP) offered to assess what assistance the Exploration and Production Research Division could provide to the Committee. During discussions with the Archaeological Director of the Mary Rose Committee, Margaret Rule, the most urgent requirement was deemed to be a more accurate site plan of the exposed frames to supplement the survey checks using offset tape measurements from a rigid six metre steel pole positioned over the frame heads. The agreed survey procedure included seabed mapping with a side-scan sonar followed by a diver based underwater acoustic survey of the site using a Rangemeter developed by Sonardyne International Limited (Partridge, 1970⁽³⁾).

An underwater reconnaissance of the wreck site and surrounding seabed was carried out on 28 October 1975 from the *Mary Rose* diving boat *Roger Grenville* and a side-scan sonar survey undertaken between 29 and 31 October 1975 using a Southampton based vessel, the *Will Bonne*. The underwater acoustic survey of the *Mary Rose* using the Rangemeter system purchased for the Mary Rose (1967) Committee by BP for the project was carried out between 10 and 17 November 1975 (Kelland, 1976⁽⁴⁾). Additional survey measurements were carried out by Sonardyne from the dive support barge DSV *Sleipner* in 1979 using a Rangemeter and a vessel-based Long BaseLine (LBL) system.

1.2 Recovery Operation

Following the detailed archaeological excavation of the *Mary Rose* between 1979 and 1982 (Rule, 1983⁽²⁾), Sonardyne offered to assist with monitoring the position of the hull and its support cradle during the recovery operation using underwater acoustic equipment and survey procedures developed to support world-wide oil field operations (Kelland, 1994⁽⁵⁾). This work was carried out between 29 September and 11 October 1982 from the *Mary Rose* dive support barge *Sleipner* (Dobbs, 1995⁽⁶⁾).

1.3 Absolute Position

The absolute position of the *Mary Rose* site was determined in Global Position System (GPS) co-ordinates in 1996 by the Plymouth Maritime Archaeological Interest Group and Sonardyne using a prototype shallow water seismic positioning system and Homer Pro diver locator (Holt, 1996⁽⁷⁾).

1.4 Excavation 2003 to 2005

In 2002 the Ministry of Defence considered the possibility of widening and straightening the channel approach to Portsmouth Harbour to accommodate two new aircraft carriers. The dredging work would have affected the site of the *Mary Rose* which still contained important timbers and artefacts left behind when the hull was recovered; the potential remains of the bow castle also had never been investigated. A 30-day period of work on site was undertaken by the Mary Rose Trust starting in July 2003 which continued for three summers. The excavation and survey work was carried out by the Mary Rose Trust from the dive support vessel *Terschelling* using both Long BaseLine (LBL) and Ultra Short BaseLine (USBL) acoustic positioning equipment supplied by Sonardyne (Holt, 2005⁽⁸⁾).

This review outlines the survey techniques used and discusses the results of each operation and was prepared to coincide with the opening of the new Mary Rose Museum in the Portsmouth Historic Dockyard in 2013.

2 Side-Scan Sonar Survey – 1975

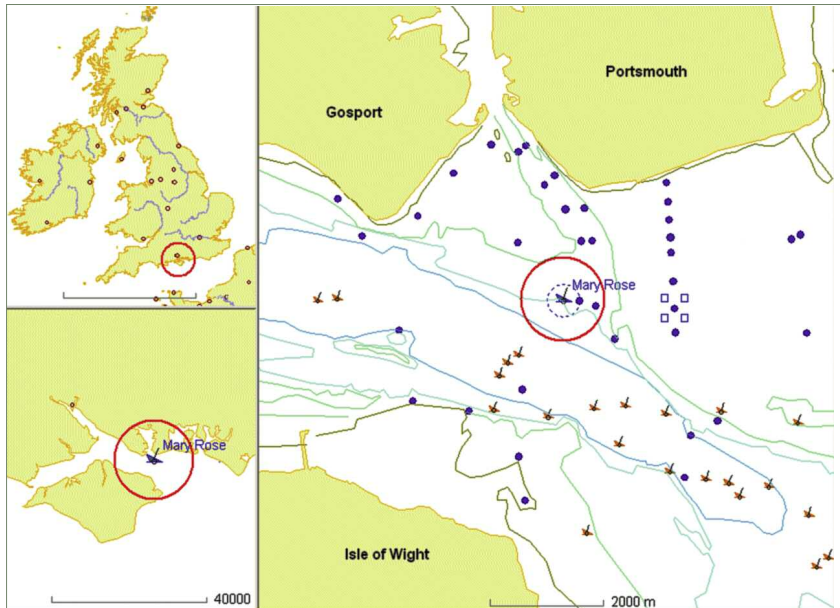

Figure 2: Wreck Site Location. (3H Consulting)

Prior to undertaking the diver based Rangemeter underwater acoustic survey, a side-scan sonar survey was carried out over the site to establish the position of the *Mary Rose* and check for underwater obstructions (Fig. 2).

The equipment transmitted a directional 105kHz acoustic signal (narrow in the horizontal plane and wide in the vertical plane) from a transducer pole mounted on the starboard side of the survey vessel towards the seabed (Fig. 3).

Acoustic signals backscattered from the seabed and detected by the transducer were processed and printed on a facsimile wet paper recorder.

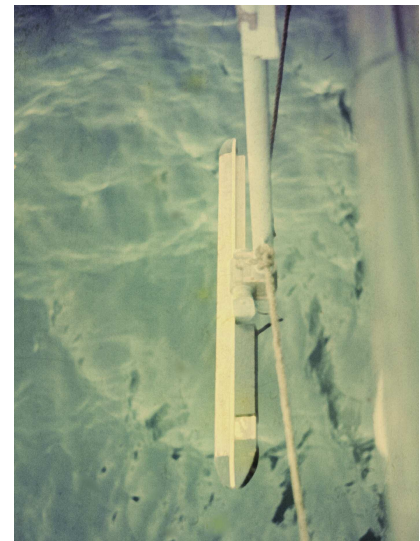

Figure 3: Side-Scan Transducer Mounting on the Will Bonne. (Author)

Figure 4: Side-Scan Sonar Plot. (BP)



Positioning for the side-scan sonar survey used a Trisponder microwave system operating in the X band between 4500 – 9000 MHz. This system measures the travel times of pulses transmitted from a mobile unit installed on the survey boat and transponders set up at remote slave stations. The two slave units used during the survey were installed alongside the flag staffs at Gilkicker Point and Southsea Castle and trained to cover the site of the *Mary Rose*. The National Grid co-ordinates of each slave station were derived from information supplied by the Ordnance Survey and Ministry of Defence (Navy).

The position of the sonar transducer was determined in National Grid co-ordinates from the intersection of two range circles. The Trisponder system has a nominal accuracy of +/- 3 metres, but requires range calibration over known distances. It had been planned to use Spit Sand Fort as a reference point, but it proved impossible to approach sufficiently close to the Fort due to the shallow water. Calibration was therefore carried out by checking the baseline readings at each slave station at the beginning and end of the survey.

Survey runs were completed in a North/South – East/West box grid around the site using the wreck marker buoy as a visual reference point. Trisponder ranges to the slave stations were recorded at approximately 30 second intervals with numbered event marks added to the sonar records. As soon as the approximate position and orientation of the *Mary Rose* had been determined, further sonar runs were made maintaining the survey boat at an optimum sonar range from the wreck.

The sonar survey had to be undertaken in near gale force conditions, which adversely affected the record quality due to vessel motion and aeration in the water column, as is apparent from the typical sonar record shown in Figure 4

This sonar record was obtained when running in a southerly direction approximately parallel to the centre line of the *Mary Rose*. The port side of the wreck can be identified together with an elongated anomaly that was considered to be associated with the stern. A diving platform

that had sunk close to the *Mary Rose* during gale conditions in August 1973 lies some 35 metres to the East of the location. The four Rangemeter transponders were positioned to the West of the site to avoid acoustic interference from the platform.

The sonar survey indicated that the seabed morphology and composition was quite varied over the site. The seabed immediately around the *Mary Rose* was predominantly flat with occasional ridges up to 0.75 metres high.

3 Rangemeter Survey of the *Mary Rose* – 1975

3.1 Principle

The diver based Rangemeter ‘trilateration’ survey technique (measuring distances from an object to two or more control points whose positions are known) used to plot the positions of the exposed frames of the *Mary Rose* was based on survey procedures developed during accurate underwater mapping of pipelines in BP’s West Sole field in the North Sea (Kelland, 1976 ⁽⁴⁾). Trilateration surveys in underwater archaeology frequently measure distances using tape measures, which is time-consuming and only viable over distances under 30 metres in conditions of reasonable visibility and low currents (Holt, 2003 ⁽⁹⁾). These limitations are overcome using a diver operated ranging device, the Rangemeter, (Fig. 5) to interrogate acoustic transponders.



Figure 5: Author holding the *Mary Rose* Rangemeter. (BP)

3.2 Rangemeter

The Rangemeter could be used with up to five transponders with each transponder being interrogated on a unique frequency (56kHz, 57kHz, 58kHz, 59kHz or 60kHz) selected by a front panel switch and replying on a common frequency of 62kHz. The time interval between the transmission and the reply signal arriving and being detected back at the Rangemeter is directly proportional to the distance from the transponder. This can be converted into a distance measurement provided the propagation speed of sound waves in sea water is known. The measured range, which represents two-way travel time in milliseconds, was presented as a four digit red visual display.

The Rangemeter had a detection resolution of 0.1 milliseconds, equivalent to a range resolution of 75mm at a sound speed of 1500 metres per second. There was an audio output to a bone conduction transceiver which the operator placed under his hood against his skull. Each transponder reply incorporated a unique tone burst signal which was fed to the earpiece and used to assist transponder recognition and selection. A magnetic compass unit mounted on top of the Rangemeter (*Fig. 5*) was used to determine bearing information.

3.3 Underwater Tape Recorder

To utilise efficiently the fast data collection rate possible with the Rangemeter (a set of readings to four transponders could generally be taken in less than one minute), the diver was equipped with an underwater tape recorder to log the results. The unit was designed and built by BP and incorporated a National Panasonic 2120 tape recorder in a clear Perspex housing, which was attached to the diver's air cylinders (*Fig. 6*).

This design enabled the operator's dive partner to monitor the performance of the recorder underwater. There was an external ON/OFF switch and output socket for a bone conduction transducer, which the diver positioned under his hood. When the operator had confidence in a Rangemeter reading, the appropriate transponder number and range

Figure 6: Underwater Tape Recorder. (Author)

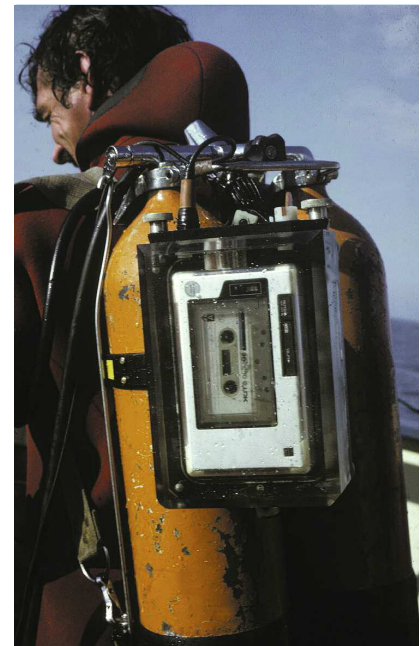
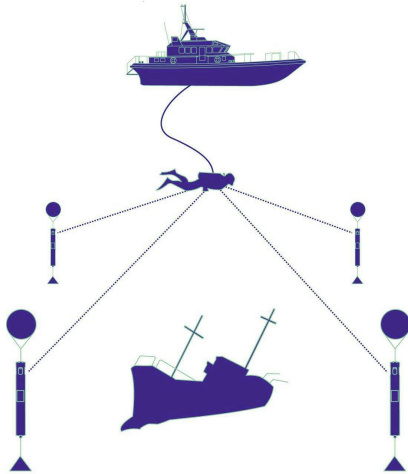

Figure 7: Long BaseLine (LBL) Survey Method. (Sonardyne)



value was read out and recorded. The operator could process the data after the dive and, in a noisy acoustic situation was able to select the correct range. Each data set could be qualified and relevant observations logged, such as a frame number and its position relative to adjacent objects.

3.4 Transponder Array

An array of LBL transponders is deployed on the seabed around the object to be surveyed, as illustrated in Figure 7. The ‘baseline’ or distance between each pair of transponders needs to be known accurately. This was determined in each direction during the survey of the *Mary Rose* using the Rangemeter and the relative positions of each transponder were computed. The diver then used the Rangemeter to establish the ranges between each of the numbered vessel frames being surveyed and each transponder in turn. These ranges, together with estimations of the measurement errors involved, were used to compute the optimum position of each survey point (the uniquely numbered tag on each frame) relative to the transponder array.

It is normal practice to deploy a minimum of four transponders to provide redundancy since the relative accuracy of their computed positions can be determined from an analysis of the measured baselines and depths of each transponder. The baseline measurements can be repeated to ascertain if any one of the transponders has moved. The relative accuracy of each survey point can also be determined from the ranges measured to three or more transponders. This is very important since the Rangemeter operator cannot be confident that the measured range represents the straight line distance between the survey point and a transponder. If some object lies between the diver and a transponder, the Rangemeter could display the range from a signal that has undergone multipath transmission (for example, reflected from the sea surface) due to masking of the direct signal path. Provided only one of the four measured ranges represents a multipath signal, it can be identified from the error analysis and eliminated from the position calculation.

3.5 Transponder Frames

To provide the highest position accuracy the four transponders were deployed in fixed seabed frames. The initial design comprised a four-legged metal tripod mounted on a one metre square metal frame, the whole structure weighing 250 kilograms. The transponder was mounted in an upright cylindrical collar welded to the base-plate, permitting emplacement and/or recovery by divers.

There was a strong possibility that some of these frames could sink under their own weight into the soft sediments around the *Mary Rose*. It was therefore essential to determine the weight bearing properties of the sediments before finalising the design of the frames. The overall dimensions of the frames were controlled by the height that the transducer of each transponder needed to be above the seabed to give acoustic 'line-of-sight' to any part of the hull (1.5 metres). The pressure loading of a two metre high frame with a one inch metal base-plate was calculated and a 25 kilogram test weight with an identical loading fabricated. The test weight was lowered to the seabed at different locations around the *Mary Rose* and a diver attempted to both push and pull it laterally into the seabed (Fig. 8).

The trials confirmed the weight bearing properties of the seabed were adequate to support the transponder frames, but indicated that the frames could slip sideways if subjected to sufficient lateral force. Metal skirts were therefore added to the frame base-plates to prevent any lateral movement, as shown in Figure 9.

3.6 Transponder Frame Deployment

Provisional drop co-ordinates for the four transponders to provide good survey coverage over the site and give acoustic lines of sight to each transponder from the *Mary Rose* were selected on the basis of the side-scan sonar results, and the required ranges to the Transponder slave stations determined. Deployment of each transponder frame was carried out at slack water with the vessel being conned to the preferred position and



Figure 8: Frame Loading Tests. (BP)



Figure 9: Typical *Mary Rose* Transponder Frame. (BP)



the transponder frame swung overside (*Fig. 9*). The transponder was then installed and the frame lowered to the seabed. A Munroe quick release mechanism was used at the first two locations and the frames released with a messenger weight. Because of problems with this system, the third and fourth frames were cut loose on the seabed by a diver. To prevent snagging and possible parting as the tide swung, the marker buoy line of each frame was transferred to a sinker weight attached to the base of the frame by a 10 metre ground line.

Figure 10: Taking Rangemeter Measurements.
(Nick Rule)



3.7 Underwater Survey

The diver based survey involved the following three separate tasks:

1. Baseline measurements between the array transponders
2. Survey of selected *Mary Rose* frames
3. Determination of propagation sound speed

Baseline Measurements

The travel times between each pair of transponders were measured in both directions at regular intervals throughout the survey with the Rangemeter transducer aligned carefully with a transponder transducer. Multiple ranges were measured on each occasion and the Rangemeter tuned to the optimum response. The optimum values were recorded manually on a pre-prepared data board using an underwater pen.

Survey of *Mary Rose* Frames

Due to limited time available and the bad weather conditions, the underwater survey measurements were carried out by the same pair of divers with the survey being limited to a selection of the exposed wooden frames. The author took the measurements whilst the second diver acted as stand-by and ensured that the wooden frames being surveyed were those selected by the Archaeological Director. The second diver also switched on the underwater tape recorder and monitored its operation.

To ensure that the diver could position the Rangemeter over the centre of each of each frame, a one metre metal tripod was carefully positioned vertically above the centre of the frame in turn, as illustrated in Figure 10.

Adjusting the tripod was time consuming due to the poor visibility and the large variation in the seabed level on the inboard and outboard sides of each frame (up to one metre). The two-way travel times were then measured sequentially from the top of the tripod to the four transponders and the range values recorded using the underwater tape recorder. Twenty points on the hull were surveyed during two dives, each of 30 minutes.

The corner points of the diving platform that had sunk to the East of the *Mary Rose* in 1973 were also surveyed.

Determination of Acoustic Propagation Sound Speed

To utilise the high measurement precision of the Rangemeter, the acoustic propagation conditions were monitored throughout the survey. Measurements of the temperature and salinity were taken at 15 minute intervals during the underwater survey work and the speed of sound at the survey depth calculated from these parameters using Wood's equation:

$$V = 1410 + 4.21 T - 0.037T^2 + 1.14S + 0.018D$$

Where:

T – Temperature in degrees Celsius

S – Salinity in parts per thousand (ppt)

D – Depth in metres

Individual computed values were considered accurate to +/- 0.5 metres/second and Figure 11 shows the variation in sound speed at the times when the Rangemeter measurements were being taken. The values

Figure 11: Representative Sound Speed Variation. (BP)

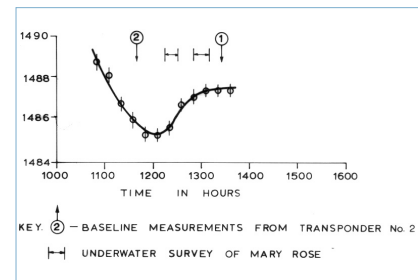

used to calculate the range measurements on each dive interpolated from the logged data are considered accurate to +/- 0.3 metres per second.

3.8 Survey Results

Baseline Measurements

The length of each baseline was taken as the mean of the values determined from the daily baseline measurement checks and the associated interpolated sound speed value. The variation in the measurements for one baseline is shown in Table 1 and Figure 12

Table 1: Baseline Values between Transponders 1 & 3.

Date	Sound Speed (metres/second)	Measured Range (two-way times) (milliseconds)	Computed Value (metres)
12.11.75	1490.4	127.10	94.71
12.11.75	1489.3	127.20	94.72
13.11.75	1489.4	127.15	94.69
13.11.75	1490.9	127.05	94.71
14.11.75	1487.4	127.25	94.64
16.11.75	1490.6	127.05	94.69
Mean	—	—	94.69 +/- 0.03

Figure 12: Baseline Variation between Transponders 1 & 3. (BP)

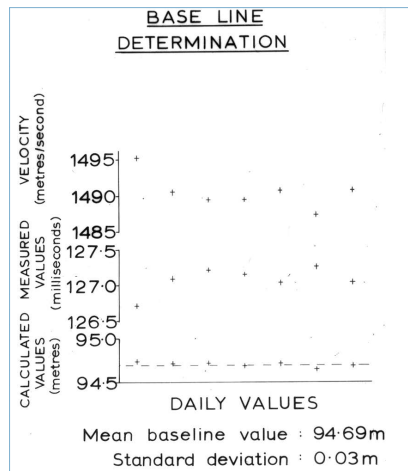

The relative accuracy of individual baseline measurements was considered to be +/- 40mm, which is consistent with the spread seen in Table 1. The relative accuracy of the mean baseline values was probably better than +/- 30mm.

An estimation of the relative accuracy of the acoustic baseline calibration was derived from the comparison between the measured length of one of the six baselines and the value calculated from the other five baselines. The difference, 40mm, was within the expected accuracy of the Rangemeter system.

A least squares adjustment of the baseline calibration was superimposed on the National Grid co-ordinates of each transponder drop position established from the Trisponder readings. Best fit values were

selected and made consistent computationally with the adjusted Rangemeter readings. The resulting National Grid co-ordinates were used as the control points for the Rangemeter survey.

Frame Measurements

The four ranges measured from the *Mary Rose* frames to each transponder were used as an input for a computer program that computed the National Grid co-ordinates relative to the transponder array, together with an estimation of the position error in each axis. The positions of each point are shown in Figure 13. If the computed position error is better

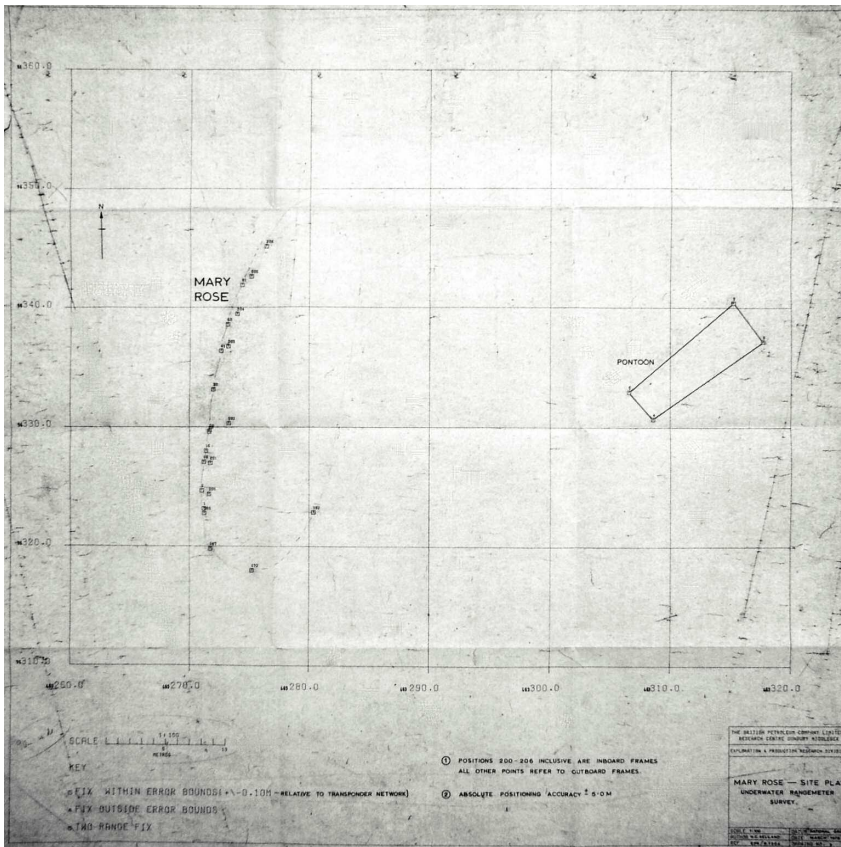

Figure 13: The original plot of Rangemeter Positions. (BP)

than +/- 100mm the plotted points are represented by a square and if worse by a triangle.

There is a distinct curve to the exposed frames on the port side of the *Mary Rose* with the single frame surveyed to the South East associated with the starboard side. The centre line of wreck had a true orientation of approximately 010 degrees. The sunken diving platform lay some 35 metres to the East of the *Mary Rose*.

The Rangemeter survey results were used by Nick Rule (Pers. Comm.) to correct the positions of the exposed frames that had been determined using offset tape measurements taken from a six metre rigid steel pole positioned over the frame heads shown in Figure 14.

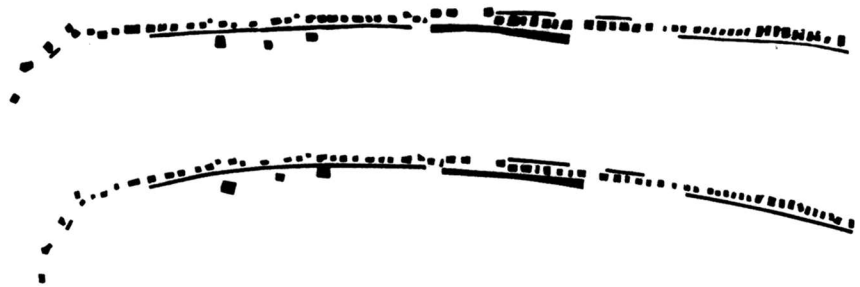

Figure 14: Rangemeter data used to correct Offset Tape site survey. (Nick Rule)

(Top Plot by tape in 1971, bottom Plot corrected by Rangemeter in 1975).

Comments

1. As bad weather limited the Rangemeter survey programme there was only time to position selected frames. The speed with which the work was carried out in view of the poor visibility demonstrated the significant advantages of applying this underwater acoustic survey technique to archaeological mapping.

2. The original site plan had been achieved by establishing a rigid datum using a six metre steel pole over the heads of the exposed frames and fixing the position of each frame, inboard and outboard planking by taped off-sets from the pole. The offsets were short measurements limited to

the visual range of the diver (usually 0.5 metre) and inter-frame distances and the distance from the frames, centreline to centreline, were also recorded. As excavation proceeded north to expose the portside frame amidships, the steel pole was realigned over a selection of previously surveyed frames and newly exposed frames. “The accumulated errors in the ‘frame to frame’ measurements and inherent inaccuracies in realigning the steel pole led to an artificial straightening of the slight curvature of the wreck structure that the Rangemeter survey corrected” (Rule, 1983⁽²⁾).

3. The exposed frames surveyed using the Rangemeter established a series of surveyed points on the *Mary Rose* that were used as control reference points related to Ordnance Survey Grid for future survey measurements.

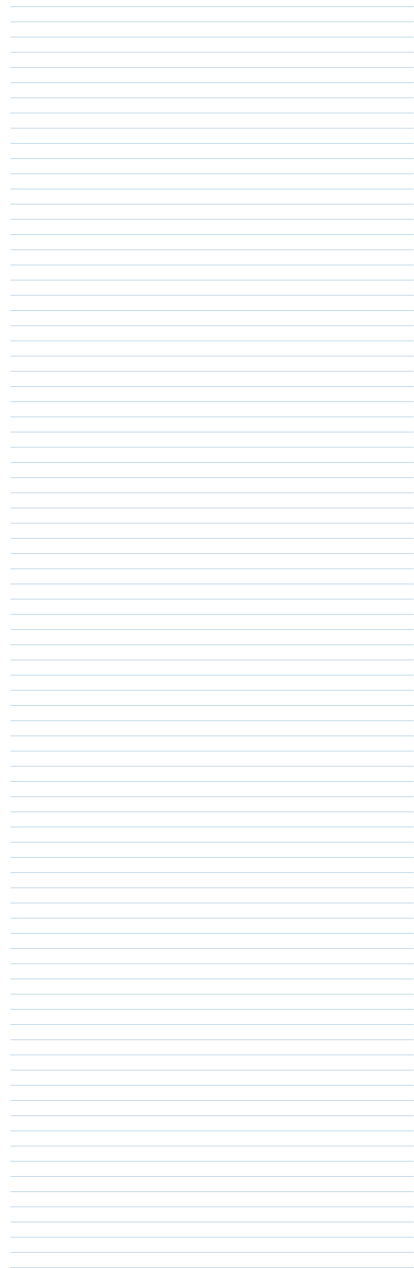

4 LBL Acoustic Surveys of the *Mary Rose* – 1979



Fig 15: *Mary Rose* diver with Remote Transducer connected to LBL Transceiver. (Nick Rule)



Additional positions were added to the original diver-based Rangemeter survey plot by the author in July 1979 using a second Rangemeter and, in November 1979, using a vessel-based Long BaseLine (LBL) acoustic positioning system operating from 25 – 36kHz. These surveys supplemented the control points used as the basis for a system of direct trilateration introduced in 1980 (Rule, 1989⁽¹⁰⁾). Using direct tape measurements from any four of these fixed control points, it was possible to survey structure and objects on the wreck of the *Mary Rose* in three dimensions as soon

as they were exposed and fix their position within the ship frame with an accuracy of +/- 0.5 metres over the length of the ship.

Three transponders were deployed in the fixed seabed frames fabricated in 1975 (section 3.5) to the West of the hull of the *Mary Rose*. Their relative positions were confirmed from baselines measured between each transponder from a remote directional transducer (Fig. 15) positioned by a *Mary Rose* diver on top of each transponder in turn and logged by the author who was in hardwire telephone communication with the diver.

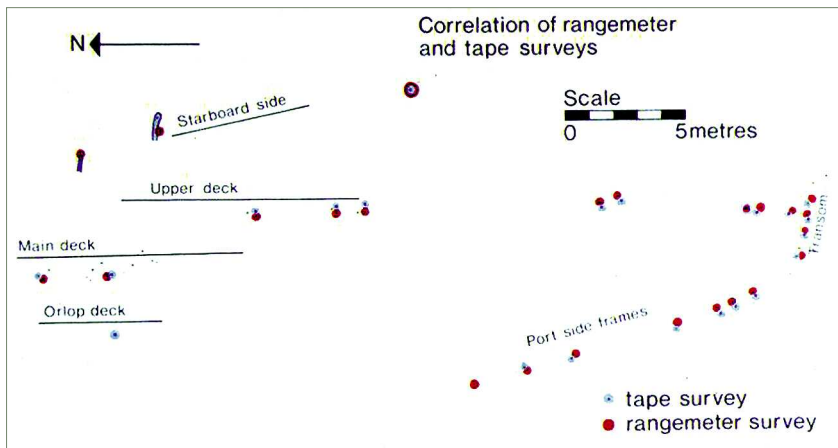

Figure 16a: Longer range surveys of the port side, the stern and the decks as they were being uncovered. (Andrew Fielding)

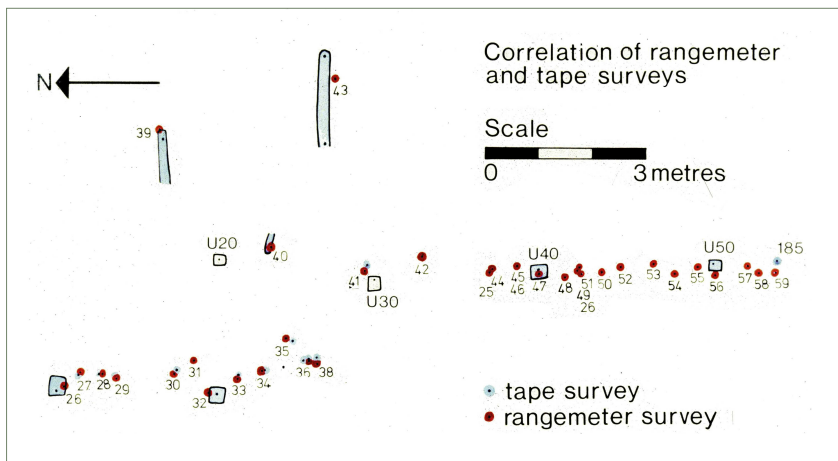

Figure 16b: Detailed position survey of the beams of the upper deck amidships and the beams of the main deck towards the bow. (Andrew Fielding)

Range measurements were then taken to each transponder from specified targets using the remote transducer and the positions for each frame derived using an LBL survey application running on an HP 9810 desk top computer. The survey included frames originally surveyed in 1975 using the Rangemeter, allowing the two surveys to be ‘tied’ together. Additional range measurements were subsequently taken from selected targets by a *Mary Rose* diver using the Rangemeter.

The two survey plots of the *Mary Rose* shown in Figure 16 prepared by Andrew Fielding in 1979 shows the excellent correlation between the tape and acoustic surveys.

5 Recovery of the *Mary Rose* Hull – 1982

5.1 Recovery Technique

Recovery of the *Mary Rose* involved the use of the giant floating crane vessel *Tog Mor*, a Lifting Frame and Recovery Cradle (Dobbs, 1995⁽⁶⁾), as illustrated in Figure 17. The remains of the hull were wired to the lifting frame using bolts attached through the hull at key structural positions (Fig. 17a). Hydraulic jacks operating on the legs of the frame raised the hull until it was free of the underlying silt. The hull, hanging from the lifting frame, could then be transferred into the cradle (Fig. 17b). Once safely in the cradle and supported from above and below, the hull was ready for the final lift out of the water (Fig. 17c).

5.2 Position Monitoring Technique

A critical requirement during the underwater transfer was to provide information to the crane operator of the relative position between the Lifting Frame and the Recovery Cradle for safe guidance as the Frame was being moved into position over the Cradle for docking. The method adopted was based on LBL positioning survey procedures developed for installing subsea structures for the offshore industry (Kelland, 1994⁽⁵⁾) using Sonardyne Compatts (Computing & Telemetry Transponders). Compatts calibrate arrays by making direct measurements of the base-lines between transponders, acoustically telemetering the data to the surface equipment for display and computation, obviating the need for the diver used during the Rangemeter surveys of the *Mary Rose* in 1975 and 1979. Data from depth, temperature and salinity sensors mounted

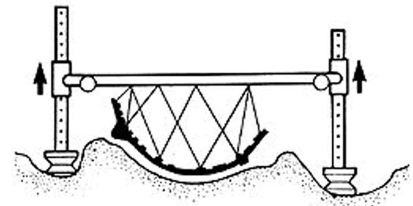

Figure 17a: Raising Hull. (Mary Rose Trust)

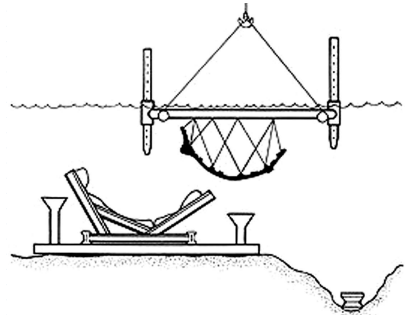

Figure 17b: Transfer of Hull. (Mary Rose Trust)

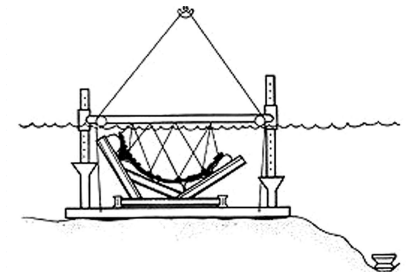
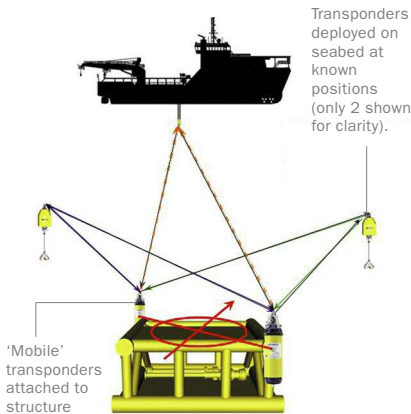

Figure 17c: Hull in Cradle. (Mary Rose Trust)

Figure 18: Structure Positioning using Compatt Transponders. (Sonardyne)



in the Compatts was used to monitor the water depth and to determine the speed of sound (determined since 2005 using direct reading sound velocity sensors). Range measurements made from two 'mobile' Compatts mounted at known locations on a structure to the array transponders together with depth measurements can then be used to determine the position and orientation of the structure, as illustrated in Figure 18.

Transponder Array

An array of three Mk2 Compatt transponders operating in the frequency band 18 – 36kHz were deployed on the seabed with floatation collars and ground weights to the East of the *Mary Rose* hull. Two 'mobile' Mk2 Compatts were attached by divers at known positions on the Recovery Cradle. The baselines between all the Compatts and their depths were measured under the control of the surface equipment installed in the survey room on the *Sleipner* illustrated in Figure 19 and connected to a transducer deployed below the keel of the vessel, to determine the position of the Cradle relative to the array transponders.

Positioning

The two 'mobile' Compatts were then removed from the Recovery Cradle by divers and redeployed on the two West facing legs of the Lifting Frame. The position, orientation and height of the Lifting Frame was determined relative to the Recovery Cradle using a software application running on an HP 9845 computer and the information displayed on the screen (Fig. 19). Figure 20 shows the plan position of the Lifting Cradle (Dotted Image) relative to the fixed position of the Recovery Cradle (Line Image) and the elevation of the two transponders deployed on the Lifting Cradle (shown deployed on the seabed on this plot). The approximately North-up orientation of the plan display is defined by the real world central position of the Recovery Cradle on the plot.

Figure 19: Acoustic Positioning Surface Equipment on *Sleipner*. (Author)



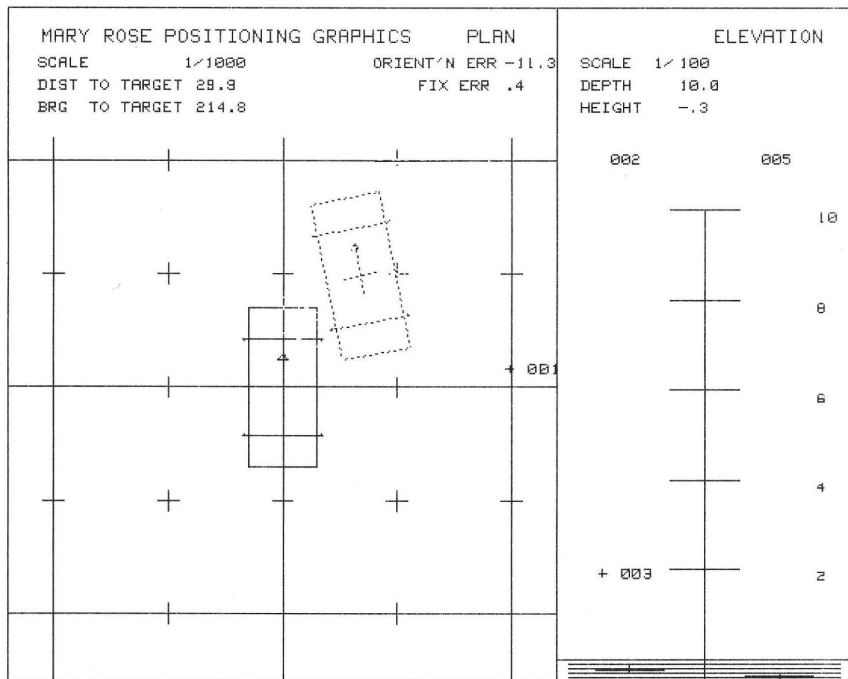

Figure 20: Representative Screen Display.
(Sonardyne)

The information displayed at the top of the screen lists the following

Display Scales	:	1/1000 (Plan) & 1/100 (Elevation)
Distance to Target	:	29.9 metres
Bearing to Target	:	214.8 degrees
Orientation Error	:	11.2 degrees
Position Error	:	0.4 metre
Height	:	-0.3 metres

Recovery

The screen dumps in Figure 21 show the movement of the *Mary Rose* hull suspended below the Lifting Cradle as it was carefully manoeuvred by *Tog Mor* from the wreck site towards the Recovery Frame. (As the target location was approached the scale of the plan display was increased.)

Clockwise from top left.

Fig 21a: 09.10hrs – Ready to lift & move West.

Fig 21b: 14.52hrs – Ready to move South.

Fig 21c: 16.20hrs – Moving South.

Fig 21d: 19.00hrs – Required position.

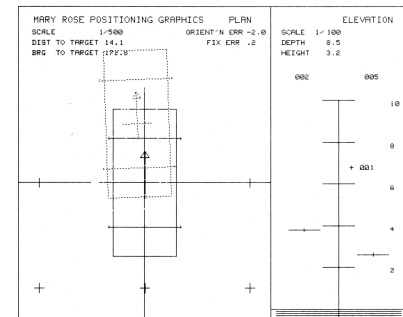
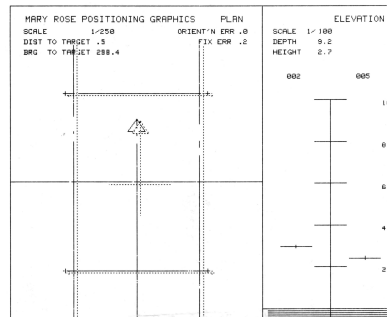
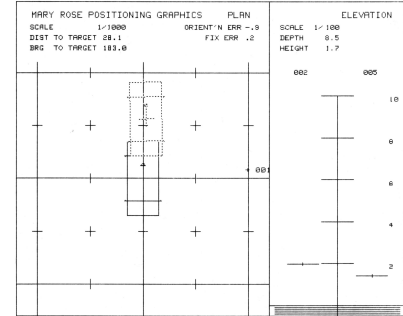
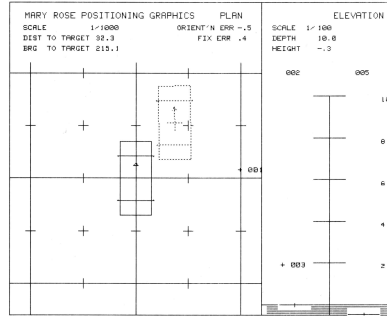

Position information was passed by radio from the survey control room on *Sleipner* to the system operators on *Tog Mor* as required and used to supplement the visual guidance system (Fig. 22).

As the Lifting Frame was being lowered into the Recovery Cradle when the acoustic and surface visual monitoring systems indicated correct positioning, it suddenly rotated anticlockwise, as shown in Figure 23a. Diver inspection showed the NE leg was outside its stabbing guide, hence preventing correct docking. (The handwritten comment on Figure 23a states: 'Reported fouled on side of rim'). The Lifting Frame was then raised to prevent damage to the *Mary Rose* hull (Fig. 23b)

The Lifting Frame was eventually docked into the Recovery Cradle under diver control late in the evening with the three remaining legs correctly sitting in their stabbing guides as illustrated in the photograph, Figure 24 taken after recovery, but with the NE leg lying just outside its

Figure 22: Visual Marker Post attached to Lifting Cradle. (Adrian Barak)



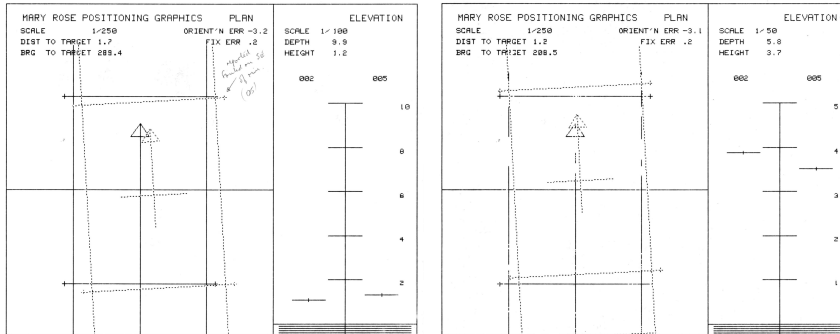

Fig 23a: NE leg outside Stabbing Guide.

Fig 23b: After raising the Lifting Frame.

stabbing guide. An in-water engineering assessment by the *Mary Rose* salvage divers confirmed that the NE leg was bent and would have to be removed – a task carried out by the Royal Engineering Diving Team using underwater cutting equipment. This corner of the frame was then stropped up to an additional fly-hook from *Tog Mor*'s crane for the lift. After the raising operation on Monday 11th October 1982 (Fig. 25), a replacement leg was welded back into position by a member of the *Mary Rose* Diving Team before the whole structure was towed home to Portsmouth that evening on a barge.

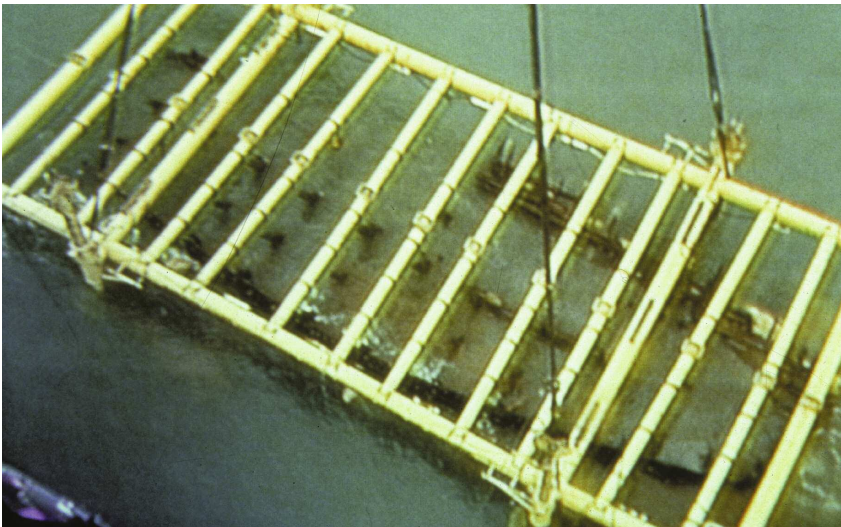

Figure 24: A Lifting Frame Leg sitting in its Stabbing Guide. (Author)

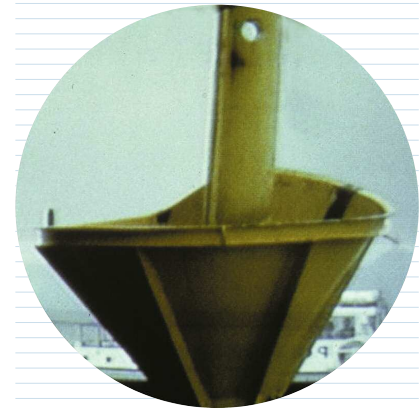

Figure 25: *Mary Rose* emerging from the Solent. (Mary Rose Trust)

6 Absolute Positioning – 1996

In 1996 a survey was carried out to compute the positions and position accuracies for the remaining survey points and other objects still visible on the seabed on the *Mary Rose* site. This work was part of the long-term monitoring of the site but would also provide a more accurate position for the wreck on the WGS84 datum used by the then newly available Global Positioning System (GPS).

The techniques used to position the site were designed for the oil prospecting industry to position seismic cables laid on the seabed in shallow water (*Fig. 26*). Two acoustic positioning techniques were used in conjunction to improve the accuracy of the final result. Both techniques require acoustic marker transponders to be deployed around the site and were deployed with surface marker buoys so they could be retrieved without using divers.

The distances between four reference transponders in fixed frames on the seabed were measured using a Homer Pro diver locator operating at 30 to 60kHz, a development of the Rangemeter discussed in section 3.2. Relative depth measurements were also made at three of the transponders and one survey control point. The positions of the transponders were computed relative to the GPS satellite network using a vessel fitted with a Differential GPS (DGPS) receiver and a Sonardyne Mini RovNav acoustic interrogator fitted to a pole over the side of the ship. DGPS positions were recorded at the same time as distance measurements were made from the acoustic interrogator to each transponder as the boat was manoeuvred around the site.

The acoustic distance measurements between each transponder,

Figure 26: Prototype seismic positioning system used in 1996. (Author)



the relative depth measurements, surface positions and surface to transponder range measurements were processed by a software application that computed the best estimate of position and an estimate of position error for each of the marker transponders and the survey points.

Only four points on the site were positioned and none of them had been included in the original hull survey. None of the original survey points could be positioned as they all had been fitted to the hull and were removed when the hull was raised and recovered. So although the hull hole could be positioned, the original position of the hull within the hole could not be determined directly. (It was subsequently realised that this could be achieved using the positions of the sunken diving platform established in 1975 and 2003 – section 7.1)

7 Site Excavation 2003 – 2005

7.1 Survey Operations – 2003

Equipment

A multi-phase fieldwork project was defined by the Mary Rose Trust in 2003, which was to run over a period of 3 weeks. The aims of this project were to recover remaining buried artefacts and debris from the seabed, excavate small trenches into the spoil mounds resulting from the 1979 – 1982 excavation to assess their archaeological significance, undertake visual and magnetic searches and delimit the extent of the debris field (Hildred, 2011⁽¹¹⁾). The project team used a Swan 2002 excavation ROV to remove the top layer of silt that had covered the site in recent years, leaving the delicate excavation to be carried out by divers using airlifts. A Sonardyne Fusion LBL acoustic positioning system was used to provide high accuracy positioning for the survey and dive-support vessel *Terschelling*, the crawler excavation ROV and a diver, either singly or all together (Holt, 2005⁽⁸⁾).

Standard deep water survey equipment was used despite the working depth being only 10 metres and the working area just 100 by 100 metres. The Sonardyne Mk4 Compatt transponders and transceivers used for the survey work operated at between 50kHz and 105kHz, providing acoustic ranging resolutions of 15mm. Both the transceivers and transponders were supplied with depth sensors with the transponder depths being measured remotely using through water acoustic telemetry. The transponders were also supplied with temperature and salinity sensors and used to monitor the speed of sound through the water. A personal computer running Sonardyne's Fusion LBL navigation

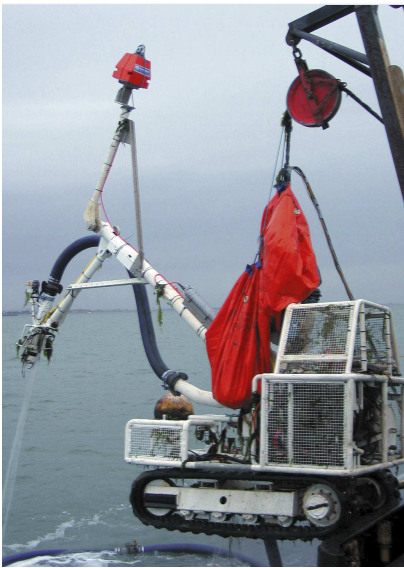

Figure 27: Crawler/excavator ROV fitted with a RovNav Transceiver. (Author)

application running under Microsoft Windows controlled the Fusion system, with Wizards and Tools used to assist commissioning, calibration and tracking.

A four-point mooring system was used to hold the *Terschelling* in position on the site so it could deploy the ROV or divers where they needed to work. The Fusion system used the on-board differential GPS (DGPS) and gyro compass to position the vessel in real world co-ordinates. The excavation ROV was fitted with a RovNav 5 LBL transceiver connected by its umbilical to the Fusion system navigation computer (*Fig. 27*).

The RovNav transceiver was connected to two remote acoustic transducers mounted at each end of the ROV's boom (*Fig. 27*), so the position and orientation of the ROV could be calculated. A high-accuracy DigiQuartz depth sensor was mounted inside the transceiver, providing high quality depth measurements in real time.

Divers using surface supply equipment did much of the work on site; they were fitted with voice communication to the surface, head-mounted camera and lights. A 2.5 metre long survey staff was used for positioning artefacts and objects on the seabed. The staff was fitted with a Lightweight Mini RovNav transceiver, a 100 metre rated depth sensor and an acoustic transducer fitted to the top (*Fig. 28*).

Acoustic range measurements made from the transducer were sent via a dedicated umbilical cable to the navigation computer to calculate the position of the diver. The staff was fitted with a bubble level as it was essential the pole remained vertical when position fixes were being taken.

Array Deployment and Calibration

Planned co-ordinates were selected on a 70 x 80 metre array for the four transponders to provide good LBL survey coverage based on data from a multibeam survey of the site carried out by Andrews Survey Ltd. Each transponder was deployed in a rigid frame to obtain the highest position accuracy (*Fig. 29*) and one transponder was fitted with



Figure 28: Diver holding survey staff fitted with a Mini RovNav transceiver. (Author)



Figure 29: Mk4 Compatt Transponders mounted in Seabed Frames. (Author)

a high-accuracy DigiQuartz depth sensor to accurately monitor the 4 metre tidal variation in the Solent.

A ‘top-down’ calibration of the array was carried out under the control of the Fusion LBL application running on a computer installed in the survey room on *Terschelling*, which determined the positions of the transponders in real world co-ordinates. The survey staff was mounted on a rigid pole deployed over the side of the vessel to keep its transducer below the keel of the vessel in line of sight of the transponders on the seabed. Acoustic range measurements were made from the transducer to all four array transponders as the vessel sailed in a circular pattern around the array. Position measurements from the DGPS receiver, vessel gyro heading and the acoustic range measurements were combined and used to calculate the positions of the four transponders. Of the 1195 range measurements recorded during the top-down calibration only 27 (2%) were rejected as being out of tolerance and the computed position error for each transponder was 0.21 metres (with 95% confidence).

A baseline calibration was then carried out to derive a higher accuracy ‘relative’ calibration for the array. Each array transponder was acoustically commanded in turn to measure multiple acoustic ranges to the other three transponders in the array and to telemeter the values to the Fusion navigation computer, using a propagation sound speed derived from the environmental sensors fitted in one of the transponders. After the range measurements had been collected, they were used to compute better positions for the array transponders using a least squares adjustment. The adjustment also used the depth measurements from each transponder and the position measurements generated by the top-down calibration. As only one transponder was fitted with a high-accuracy depth sensor, depth measurements were obtained by levelling from it to the other transponders using a diver’s digital depth gauge. In total, 96 baseline measurements were made with only one being automatically rejected as out of tolerance. The relative accuracy of the Compatt transponder array (B101, B102, B103 and B104) shown on the

bathymetric chart shown in Figure 30 was 14mm. (Note: All chart drawings use a north up convention).

Survey Accuracy Tests

A static fix test was carried out to determine how precisely the system could position the diver or ROV on the site. For this test a diver took the survey staff to a point in the middle of the site and pushed it into the seabed so it would not move. The staff was left in this position for eight minutes whilst the Fusion system continuously calculated its position every two seconds. All but two of the 235 position fixes plotted within a circle 30mm in diameter (Fig. 31).

A dynamic test was carried out by asking a diver carrying the survey staff to walk around the perimeter of the hole left by the original excavation work. Figure 32 shows the track of the diver superimposed on a

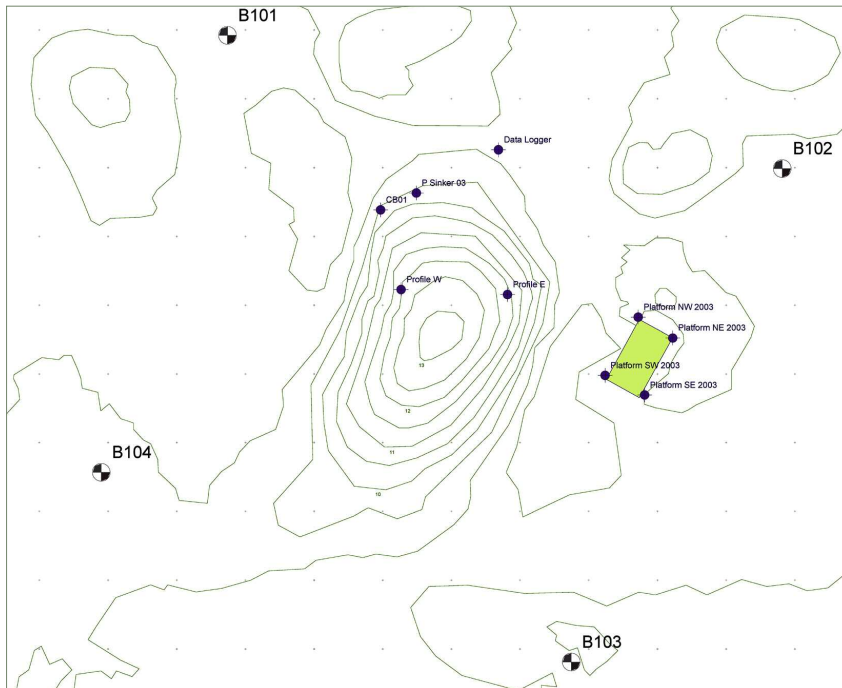

Figure 30: Calibrated Array Transponders. (3H Consulting). The chart shows the position of the Diving Platform sunk in 1973, and the significant hole left in the seabed after the hull was

Figure 31: Static Position Fix Test. (3H Consulting)

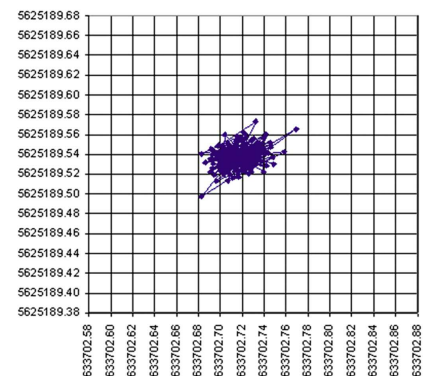
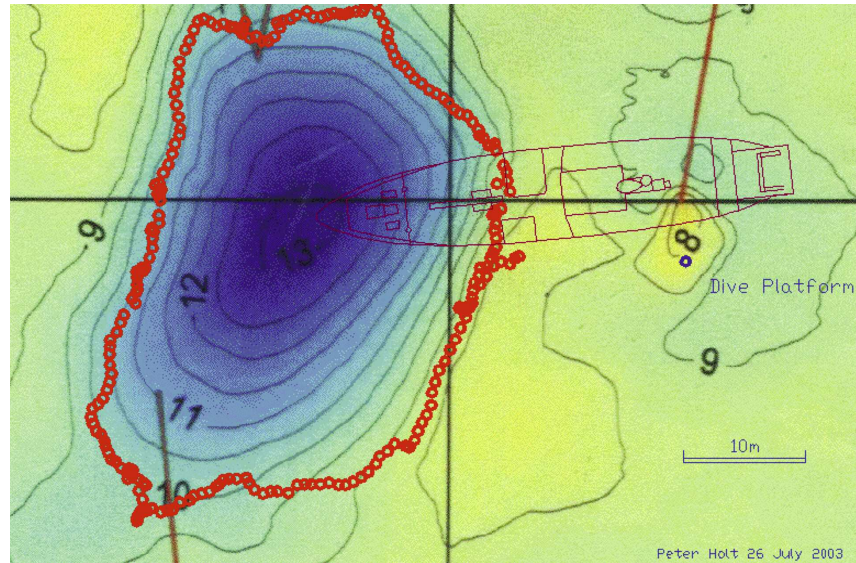

Figure 32: Dynamic Tracking Test.
(3H Consulting)



bathymetric chart derived from multibeam data; the diver leaves the dive cage on the port side of *Terschelling* and travels clockwise around the excavation hole, occasionally stopping to look at objects on the seabed.

Survey Results

The Fusion system was used to accurately position features on the site identified during the 2003 excavation shown in Figure 33 on a bathymetric image of the seabed from the multibeam sonar survey undertaken by the Archaeological Diving Unit in 2002.

At the north end of the hull depression, the end of a timber was found protruding from the seabed, (circled in red in Figure 33), which turned out to be one end of the 9 metre long stem post. Planning for the excavation had been done using the Site Recorder data management computer program, which had been developed for mapping and recording archaeology sites underwater. It had not been necessary to know the original location of the hull on the seabed at the start of the project but once the stem timber had been found this needed to be resolved.



Figure 33: 2003 Trenches and features.
(3H Consulting)

But, with no survey points from the original excavation on the seabed to tie in to the new site plan, this could not be done directly.

Fortunately, another significant seabed feature positioned during the 2003 season was the diving platform *Keepclear* that had sunk during gale conditions in 1973. This is highlighted in yellow to the East of the site in Figure 33. Fortunately the position of this platform had also been determined during the 1975 Rangemeter survey at the same time as the exposed frames of the *Mary Rose* hull were being surveyed (see section 3.8). By correlating the position of the diving platform from each data set, the original in-water position of the hull frames exposed at the seabed in 1975 could be superimposed on the current multibeam derived survey plot (Fig. 34). This solved the problem of how to relocate the recovered hull back into the new survey plan.

Figure 34 shows that two of the Rangemeter positions determined for the corners of the diving platform in 1975 were incorrect. This was due to multipath ranges having been recorded to some of the array transponders due to masking of the direct paths. Figure 34 also includes

Figure 34: Repositioning the *Mary Rose* frames exposed in 1975. (3H Consulting)

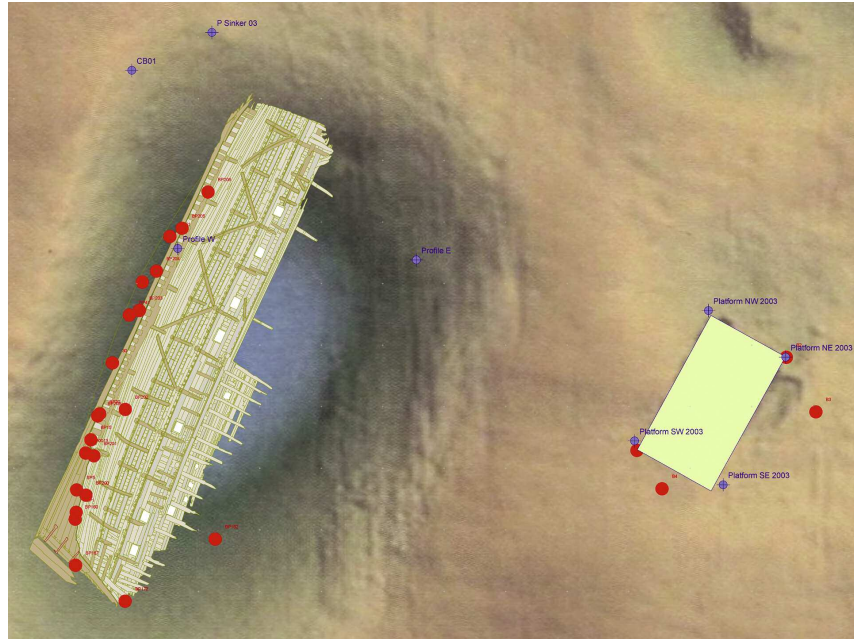

a digitised drawing of the hull timbers prepared from measurements of the hull after it was recovered, placed on the bathymetric image of the seabed.

Figure 35: Deploying the Scout USBL transceiver from Terschelling. (Author)



7.2 Survey Operations – 2004/ 2005

Scout USBL

Positioning during the 2004 and 2005 seasons was carried out using a Scout Ultra Short BaseLine positioning system (USBL) provided by Sonardyne (*Fig. 35*).

The Scout system calculates the position of divers and ROVs underwater by measuring the distance and bearing from a vessel-based transceiver to small acoustic transponders fitted to the diver or ROV. Range is calculated by measuring the time taken from sending an acoustic transponder interrogation to receiving its reply from the beacon. Bearing is derived by comparing the differences in the time of arrival of the reply

signal at the five receiver elements within the transceiver's transducer.

USBL positioning is widely used by the offshore and oceanographic industries as it offers high accuracy performance combined with ease of operation. One of its main advantages is that no other in-water acoustic equipment has to be deployed and calibrated before underwater operations can commence. The Scout transceiver operates at between 30kHz and 60kHz and provides a hemispherical pattern of acoustic coverage enabling tracking of targets from below the transceiver through to near the surface out to ranges of 500 metres. An integrated motion sensor included in the transceiver automatically compensates for the dynamic motion of the vessel and corrects the computed positions. The transceiver was connected to a computer running the Fusion USBL application in the survey room on *Terschelling* where it was combined with the vessel DGPS position to derive real-world Universe Transverse Mercator (UTM) co-ordinates for up to ten subsea targets.

Carrying on the tradition of testing new tracking systems on this site, the Scout USBL system used in 2004 was the prototype so the project provided a good opportunity to test its capabilities. The developers of this new system were involved in the project so they were able to find and fix any problems then immediately test them in a working environment. The system was so new that it had only been tested for an hour in the sea before it was put to work on the *Mary Rose* site!

Excavation Frame Deployment

The excavation of the bow area was to be done within a 16 x 4 metre aluminium grid frame supported off the seabed by spud legs (*Fig. 36*). The required position of the frame on the seabed had been calculated previously using the site information in the Site Recorder program.

The frame had to be accurately positioned on the site and deployed in one piece so this became the first task for the new USBL system. A transponder was attached to each end of the frame and the frame lowered into the water using a crane (*Fig. 36*). The USBL system tracked both

Figure 36: Deploying Grid Frame from *Terschelling*. (Author)



Figure 37: Screen shot from Scout showing the frame being tracked into position. (Author)

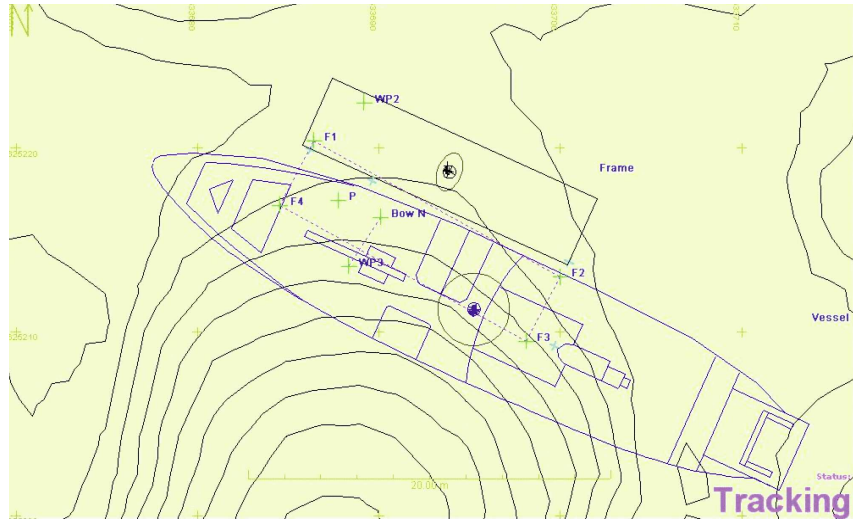

transponders on the frame at the same time, using the calculated position of each transponder to compute the position and attitude of the frame hung below the ship. The ship was then moved within its moorings to place the frame in the required position on the seabed (Fig. 37).

Figure 38: Diver Transponders. (Author)



Diver Tracking

Divers were tracked by the USBL system using transponders mounted on the diver bail-out bottle (Fig. 38). Although the USBL system was less precise than the LBL system used in 2003, the lack of cables to the diver meant that it could be used for everyday monitoring of the positions of divers on site. Static fix tests showed that position accuracies of 100mm to 500mm were achievable.

In 2005 the same Scout system was used to monitor divers' positions and for artefact mapping. The opportunity was also taken to run comparative trials between the current tone burst acoustic technology and the new Wideband technology that was being developed by Sonardyne (IMCA, 2009⁽¹²⁾). A diver was fitted with a transponder of each type and both were tracked by Scout at the same time. This was an ideal test; the

underwater acoustic conditions on site were challenging with shallow water and a flat bottomed steel boat causing reverberation as well as the bubbles from the airlifts masking the acoustic signals. These side-by-side tests proved that the new Wideband signals would perform much better than tone burst signals in such harsh acoustic conditions.

Survey Results

Figure 39 shows the positions of the complete stem timber, the collapsed port side bow timbers and the ship's anchor mapped during 2004, together with a partial digitised drawing of the main hull timbers.

Large Artefact Recovery

In 2005 the Scout USBL system was also used to position the lifting crane hook under water during the recovery of two large objects from the seabed, the 9 metre long stem timber and the 4.8 metre long anchor (*Fig. 40*).

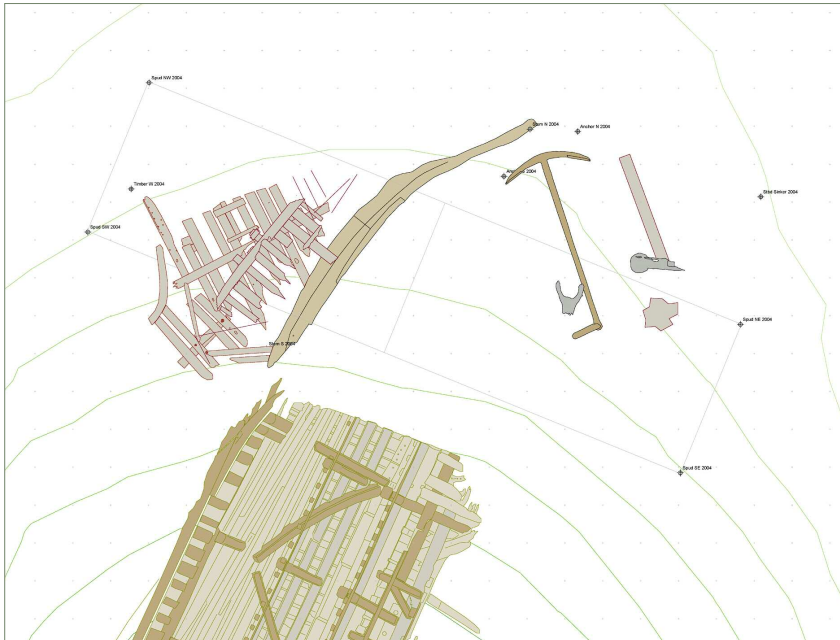

Figure 39: Features surveyed in 2005.
(3H Consulting)

Following conservation, the stem timber and anchor will be available for display in the new *Mary Rose* museum which opened on 30th May 2013. As the stem is being treated with polyethylene glycol (PEG) in a tank rather than being sprayed like the hull, the conservation can be carried out quicker than the 19 years it took for the main hull to be sprayed from 1994 to 2013. The drying programme for the hull is due to end in 2016, which is when the first preparations can be made for displaying additional items next to the hull.

Figure 40: Recovery of the Stem Timber and Ship's Anchor in 2005. (*Mary Rose Trust*) (Note the small yellow USBL transponder attached to the anchor ring).



8 Reassessing the Bow

By Peter Holt and Alexandra Hildred

The absolute positioning survey completed in 1996 highlighted the problem of establishing the original position of the hull within the hole and within the new GPS-based WGS84 survey co-ordinate frame. The rediscovery of the original 1975 Rangemeter survey plan showed precise relative positions for the hull timbers and the sunken diving platform. This, coupled with the precise absolute positions of the diving platform corners from the 2003 LBL survey, allowed us to calculate a position for the hull to a precision of 500mm.

The remains of the *Mary Rose* were found buried in the seabed, lying on her starboard side at a roll angle of 60° from the vertical. The keel was found to be intact from the stern post to the join with stem timber at the bows. The stern post is attached to the keel, it is in its original position relative to the keel and more than 7m in length survives.

If nothing unusual had happened to the hull of the ship and if natural erosion had the same pattern at the bow and stern, it could be expected that the bow would be in the same condition as the stern; intact but eroded down to seabed level. The stem would still be attached to the keel and the starboard side bow timbers attached to the stem. The stem itself would be eroded 5 metres above the line of the keel, similar to the sternpost. If the stem were still attached to the keel then the weight of the starboard side of the bow would be supported by the seabed, as has occurred at the stern. The weight of the bow would still act vertically downwards but as the hull is rotated 60° this would tend to make the stem timber fall downwards, towards the seabed. The stem would collapse directly on to the starboard side timbers or just forward of them.

The excavation of the stem timber and port side frames in 2004 suggested that the bow had been misaligned with the rest of the ship. The expected elevation outline of the hull was known so this could be rotated 60° to match the actual hull roll angle and then compared with what was found on the seabed using Site Recorder. Figure 41 shows the estimated full outline of the hull of the *Mary Rose* including the predicted position of the bow castle at the northern end.

Figure 42 shows a comparison of the position of the bow based on the stem timber exposed during 2004 (red) with the predicted position of the bow based on the surveyed position of the vessel hull (white).

Figure 41: Hull timbers and hull outline superimposed on a multibeam image of the seabed. (3H Consulting)

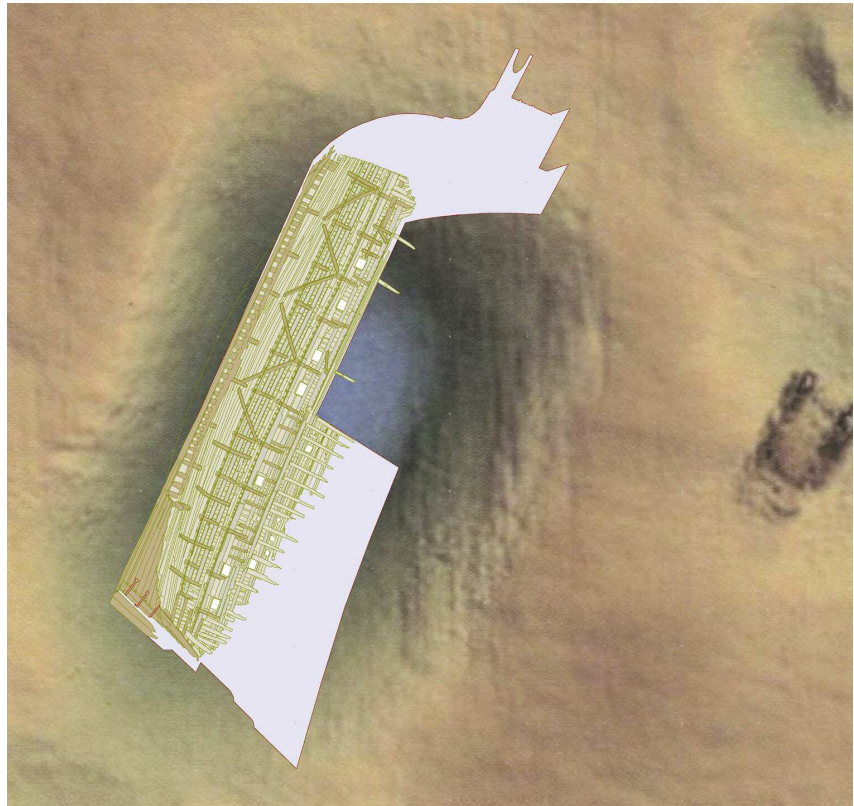

The actual stem timber fits the shape of the outline well, but the bow appears to be shifted by 2.6 metres and rotated by 30°, with the centre of rotation close to the join with the keel.

The stem timber was found together with frames from the port side of the ship along with attached inner and outer port side planking (Fig. 43). This port side structure was similarly misaligned, suggesting that these timbers were still attached to the stem when the rotation occurred. Finding port side structure by the stem but nowhere else on the ship suggests that the formation process at the bow and the formation processes acting on the rest of the hull may have been different.

The most forward part of the starboard side structure at the bow

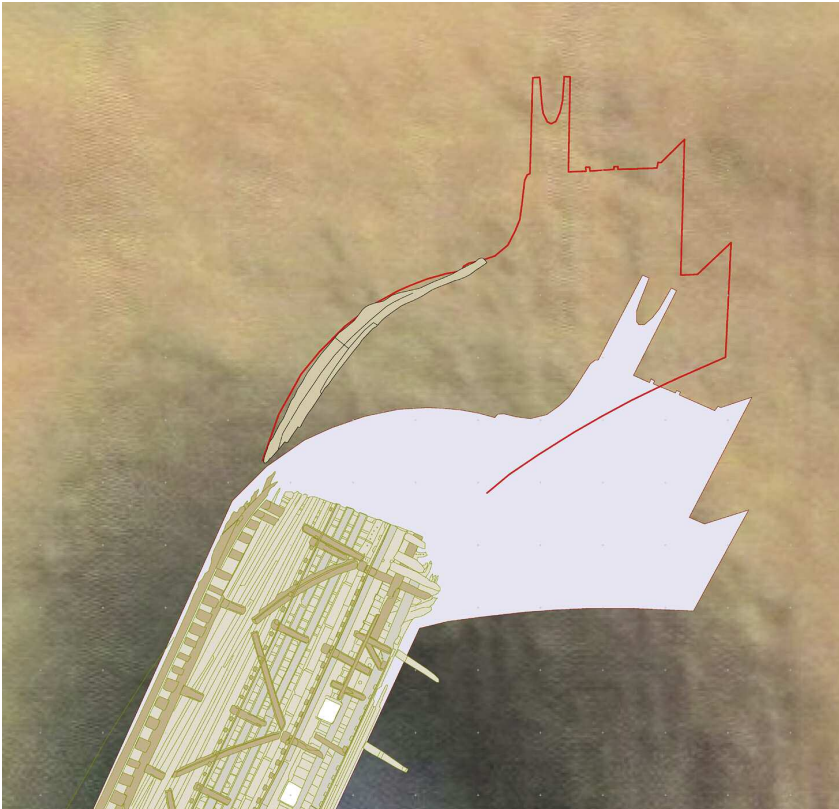

Figure 42: Estimated position of the bow rotated 30° – Red. (3H Consulting)

Figure 43: Port side structure, stem and main hull. (3H Consulting)



is also missing. The northern end of the hull timbers were sawn off before the hull was recovered but this only extended the hull between 1.5 metres to 2 metres towards the stem. It is interesting to note that the northern end of the sawn off timbers are also eroded. It seems that a section of bow up to 3 metres long is missing from the starboard side, the piece between the end of the main hull and where the stem would have been. Had the bow experienced the same processes as the rest of the hull it could be expected that the starboard side bow would remain in situ, as has occurred with the starboard hull timbers at the stern. This reinforces the theory that the processes acting on the bow were different to those acting on the rest of the hull.

Both stem and keel are substantial timbers on which much of the structural integrity of the ship would lie; the join between stem and keel would also have to be strong for obvious reasons. Thus it seems difficult to envisage a site formation process using natural forces that would separate such a strong joint, particularly if the starboard side bow timbers were still attached at the time.

The port side timbers found with the stem and the missing starboard timbers at the bow suggest that something happened to the bow that did not happen to the rest of the hull. The separation of the stem from the keel and the rotation of the keel by 30° suggest that the bow became separated from the remainder of the hull at some point. When this separation occurred is crucial in interpreting the process of site formation.

A drawing by Jonathan Adams of the hull on the seabed was adapted to illustrate the extent of the damage that a 30° rotation could cause to the hull (*Fig. 44*). The adapted drawing is not intended to represent the actual situation, but is simply a tool to demonstrate the process and to show how extreme a 30° bow rotation would be.

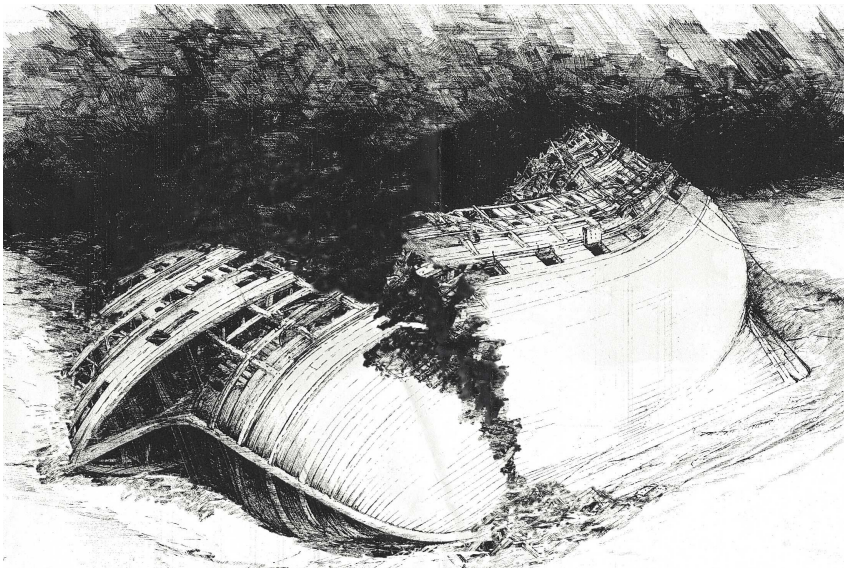

Figure 44: Revised artist impression of *Mary Rose* lying on seabed after 50 years. (Author, adapted from a drawing by J. Adams)

Whilst the accepted view has favoured natural erosion and collapse, the rotation and separation could have resulted either directly or indirectly from damage sustained during the sinking or immediate salvage attempts (Hildred, 2011⁽¹¹⁾). Whilst the erosion of the stem and inside of the port side structure suggests a period of exposure consistent with natural erosion, the condition of the outside of the hull is not known as the timbers were left in situ and extensively reburied in 2005.

As with many archaeological puzzles we find that more research analysis and even excavation may be required before the hypothesis of early damage to the bow can be proved or disproved.

9 Discussion of Survey Results

Until the development of practical underwater acoustic range measuring equipment in the last few decades of the twentieth century, underwater archaeological surveys were mainly carried out by divers using tape measures. The many problems associated with this technique have been well documented and include limited underwater visibility, limited range and the effect of both weed and currents bowing the tapes. The development by Sonardyne of the diver based Rangemeter system in the early seventies met the requirement for an accurate underwater surveying system for mapping mobile sand wave fields in critical navigation areas in the southern North Sea and was then successfully used by BP in the North Sea and off Abu Dhabi to map underwater pipelines. Following a presentation of results at a conference in Sweden in 1975, Margaret Rule arranged with BP to use the system to carry out an underwater survey of the exposed frames of the *Mary Rose* hull in the mid-seventies to supplement the site plan established using offset tape measurements from a rigid steel pole on the seabed. Notwithstanding the appalling weather conditions which severely limited the scale of the work, the results provided the first accurate survey of the exposed frames with relative accuracies better than +/- 100mm within an acceptable time scale. To quote again Dr Margaret Rule: "The accumulated errors in the 'frame to frame' measurements and inherent inaccuracies in realigning the steel pole led to an artificial straightening of the slight curvature of the wreck structure that the Rangemeter survey corrected" (Rule, 1983 ⁽²⁾). These results together with subsequent underwater acoustic measurements established a series of surveyed points on the hull of the *Mary*

Rose, that were then used as survey control points for the three-dimensional DSM tape survey, a method developed by Nick Rule (Rule, 1989⁽¹⁰⁾).

Further development of Long BaseLine (LBL) acoustic positioning systems over the past decade with the use of Wideband acoustic signals has increased the accuracy with which archaeological surveys can be carried out underwater to better than 30mm over long ranges. The improved Wideband acoustic timing precision has also required more accurate monitoring of the speed of propagation of sound in water that is now measured using a direct reading velocimeter mounted in the transponder. The time required to collect measurements and compute and display the position data has also been significantly reduced. However, despite the improved position accuracy that can be achieved using LBL, especially on large or very three-dimensional underwater sites, their use is largely limited to deep water archaeology projects because of their cost and complexity (Warren, 2004⁽¹³⁾).

The use of an Ultra Short BaseLine system on the *Mary Rose* project to control accurate positioning of grid frames on the seabed and the simultaneous positioning of multiple targets proved very successful, significantly improving operational efficiency and safety. Being much easier to use and lower cost, Scout USBL systems are now in use with a number of maritime archaeology organisations and are being used for tasks such as diver monitoring, site mapping and ROV positioning (Wessex Archaeology, 2006⁽¹⁴⁾ & Conte, 2007⁽¹⁵⁾).

10 How would it be done today?

GPS has been the most significant development in navigation and surveying since the hull of the *Mary Rose* was raised from the seabed in 1982. Nowadays, GPS would be used right from the start of the search for the wreck site. However, unless water is no more than waist deep, acoustic ranging is still essential to accurately transfer GPS positions from the sea surface to the seabed.

Traditionally, Long BaseLine (LBL) acoustic systems have provided high-precision position determination, but only relative to the frame of reference established by an array of transponders that have been temporarily fixed to the seabed. The first and critical survey procedure is to ‘calibrate’ the array. This determines the relative positions of the transponders. Calibration is one of the complexity factors that have effectively restricted the use of LBL acoustic navigation to skilled hydrographic surveyors.

LBL systems have the operational requirement that the transponders must remain rigidly fixed for the duration of the survey. If one transponder is moved by an anchor, or falls over, the errors can be detected, but the calibration process must be repeated. There follows the problem of relating the position co-ordinates of previously-surveyed artifacts to ones discovered after the re-calibration, as happened on the *Mary Rose* project when it was important to be able to relate the position of the stem timber to the hull. Secondly, operational restrictions may be imposed by seabed topography; the transponders must be high enough above the seabed to provide direct acoustic paths to the point being fixed. This may be challenging when a diver is trying to fix the position of an artifact in

a hole excavated on the seabed, as with the *Mary Rose*. Even though modern transponders may be physically small, the frames necessary to hold them rigidly above the seabed can be heavy and bulky.

If the Long BaseLine geometry were to be inverted, with the four transponders on the surface, looking downwards, the topography problem would be eased because the acoustics paths would be slanted downwards into any excavation hole. Such an ‘inverted LBL’ system would be easy to set up on a frozen lake with the transponders suspended on poles through holes in the ice. The positions of transponders could be rapidly calibrated by walking from transponder to transponder with a high-precision GPS receiver. Furthermore, the positions of the transponders, and hence the surveyed position of any artifacts on the lake bed would be ‘absolute’, i.e. with co-ordinates in real world co-ordinates and not merely relative to the transponder array frame of reference.

Without the ‘convenience’ of an ice-covered surface, the transponders of an inverted LBL system must be suspended below floating buoys. But moored buoys are not static and must be presumed to be moving slightly at all times. Therefore each buoy must be equipped with its own GPS receiver, to continuously track and record its precise GPS co-ordinates, especially for each instant when it is interrogated by the surveying diver’s or ROV’s navigation equipment. All of the range, position and precise time information from at least four buoys, and from the diver/ROV equipment, must be gathered together to compute each seabed position fix. Therefore, each buoy must be equipped with radio telemetry to transfer all of the data to a computer on a nearby boat.

These are the essentials of Sonardyne’s Mallard system, which combines the benefits of underwater ranging and GPS in one easy-to-use system. It is named after the species of ‘dabbling duck’ which feeds off the bottom while swimming with its tail in the air, the tail being analogous to the GPS and radio antennas, and its head underwater, the head being the analogous acoustic transducer, ‘feeding’ on ranges from diver or ROV.

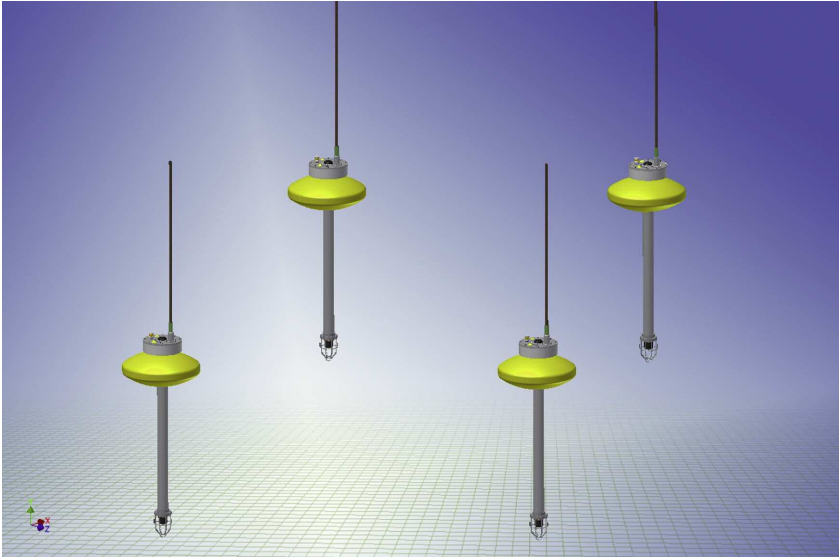

Figure 45: Representation of a Mallard Buoy array. (Sonardyne)

Mallard buoys use low-cost GPS receivers but achieve remarkable accuracy by processing the satellite raw pseudo-range and phase data in the boat's computer and combining this with 'corrections' data for the errors in GPS signals induced by the atmosphere and satellite orbit variations. Corrections previously required a dedicated UHF radio telemetry link from the shore, but now the data can be acquired by mobile phone via the Internet.

The diagram in Figure 45 illustrates four Mallard buoys floating on the surface with transducers fitted to the bottom of the keel-tubes and the two antennas on top of the float. There would be mooring ropes to sinkers on the seabed. A Mallard buoy is seen in action in Figure 46 with the restored 19th century trawler *Leader* in the background.

The aim of Mallard is to provide 'easy-to-use underwater navigation for the iPad generation'. The buoys are easy to handle (Fig. 47) and start tracking an underwater object marked with a transponder or cable-connected acoustic device almost immediately, as illustrated in Figure 48 which shows a Falcon ROV with a docking funnel positioned below

Figure 46: Mallard buoy in action. (Sonardyne)



Figure 47: Mallard buoys are easy to handle.
(Sonardyne)



a Mallard tracking transducer. Sound speed information is monitored on a regular basis with a velocimeter to provide the high in-water system positioning accuracy.

The area of coverage is limited by the license-free radio regulations to under a square kilometer. But most wreck sites are small and a square of seabed 100 metres by 100 metres takes a considerable amount of diving time to search, so limited coverage is not a significant operational limitation. The Mallard screen shot in Figure 49 shows the short track of the sledge illustrated in Figure 50 being towed along the seabed during dynamic trials in a Plymouth marina. The sledge was fitted with two transponders at either side (Fig. 50), providing the double track; the sledge had aligned itself at the left hand end of the track to superimpose the two tracks. Depth and tidal currents also present operational limitations since the buoys need to be moored, but these present problems to diving and ROV operations anyway.



Figure 48: ROV equipped for Mallard tracking.
(Sonardyne)

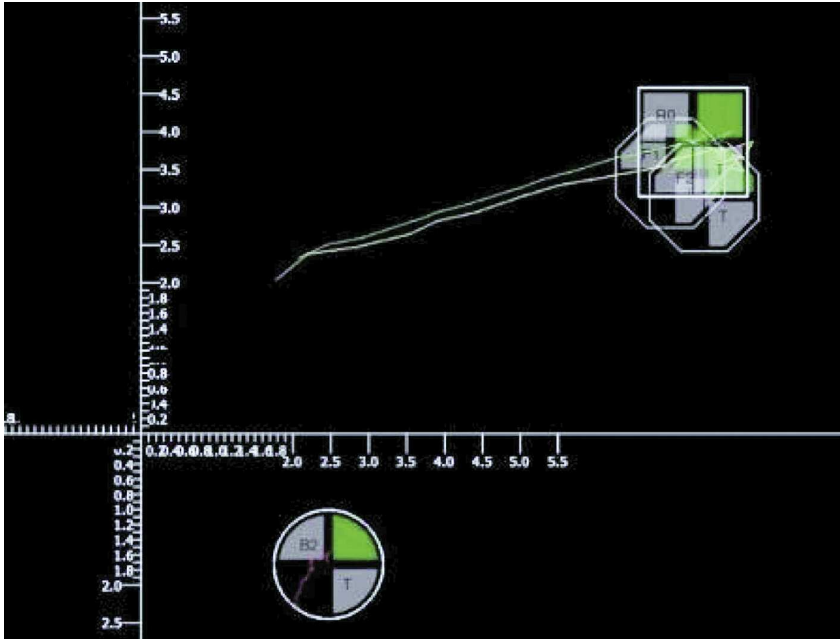
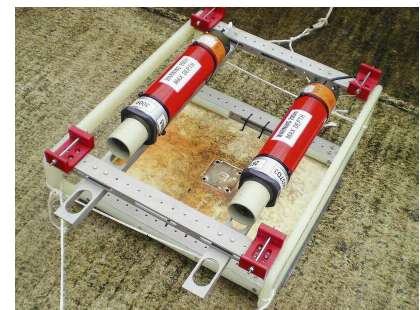

Figure 49: Dynamic Mallard tracking test. (Sonardyne)

It was the desire to navigate divers accurately and map the seabed, especially the sites of ancient shipwrecks, that led John Partridge to develop the Rangemeter between 1964 and 1970, which was first used on the *Mary Rose* project in 1975 by one of the authors. This led to the founding of Sonardyne in 1971. John's other ambition was to make diving safer by tracking divers from the surface and automatically generating alarm signals when a diver gets into difficulties. But it was the birth of the UK offshore oil industry that provided the economic driver for the commercial growth of Sonardyne and UK underwater technology in general. Sadly, there has been little equivalent commercial drive for the development of underwater acoustic technology specific to diving, although the Rangemeter was adapted to relocate lost diving bells marked by an emergency transponder following a tragic incident in the North Sea in 1979, which emphasised the need for an efficient and fast diver-based relocation technique. Instead, the commercial thrust has been to

Figure 50: Mallard test sledge fitted with two transponders. (Sonardyne)



eliminate divers from underwater work situations and replace them by ROVs. Though there has been invention in the area of underwater navigation and safety aids for divers, there has been little innovation. So sadly, few of the inventions have turned into products that sports divers and underwater archaeologists would want to buy, could afford to buy and would find easy to operate. Sonardyne's new Mallard system aims to provide the same simple, precise and cost-effective underwater positioning that GPS now provides on land.

Acknowledgments

The authors acknowledge the support of the British Petroleum Company Limited supplying the survey equipment used during the underwater acoustic mapping of the exposed frames of the *Mary Rose* in 1975 and with the preparation of the first Rangemeter survey plan.

The underwater positioning equipment used during all subsequent acoustic mapping operations was supplied by Sonardyne International Limited and the authors acknowledge the enormous support and encouragement of John Partridge throughout the project.

The comparison plots of the exposed hull frames using offset tape measurements and the Rangemeter and some operational photographs were provided by Nick Rule and the 1979 acoustic/ tape correlation plots by Andrew Fielding, whose important contributions the authors acknowledge.

The technical and operational support of David Lawes from Sonardyne and the *Mary Rose* dive team during the recovery operation of the hull in 1982 was invaluable.

The underwater acoustic surveys of the *Mary Rose* were completed with the enthusiastic support of Dr Margaret Rule and the Mary Rose Trust dive team with the willing underwater assistance of Adrian Barak, Chris Underwood, Jon Adams and Christopher Dobbs, often in very trying conditions.

For the 1996 survey work our thanks go to the PMARIG team and for the excavation our thanks go to the many divers, archaeologists and surveyors involved. Our particular thanks go to Paul Dart as without him much of this work would not have happened.

All of the fieldwork mentioned here from 1996 onwards was done under the direction of Alexandra Hildred, who planned and executed the successful 2003–2005 excavation, which still remains one of the most technologically advanced underwater excavations done to date. Nigel Boston and the crew of the survey vessel *Terschelling* provided a base for the operations and the expert seamanship essential for such a large archaeology project.

The authors acknowledge the editorial support of Christopher Dobbs and Alexandra Hildred and their many useful suggestions and last but not least, the assistance of Sonardyne International Ltd with the publication of this Review.

References

- 1 McKee, A., 1973, "King Henry VIII's Mary Rose", Souvenir Press, London, ISBN 0 285 62091 6.
- 2 Rule, M.H. 1983, "The Mary Rose – The Excavation and Raising of Henry VIII's Flagship", Second Edition, Conway Maritime Press, London, ISBN 0 85177 289 7.
- 3 Partridge, C. J., 1970, "A Personal Precision Acoustic Navigation System for Exploration Diving", Proc. IERE Sym. on Electronic Engineering in Ocean Technology. Swansea, Sept 1970 pp. 423–446.
- 4 Kelland, N.C., 1976, "A Method for Carrying Out Accurate Planimetric Surveys Underwater", The Hydrographic Journal Vol. 2 No. 4, Sept. 1976 pp. 17–32.
- 5 Kelland N.C. 1994, "Developments in Integrated Underwater Acoustic Positioning", The Hydrographic Journal No 71, January 1994 pp. 19–27.
- 6 Dobbs C.T.C., 1995, "The Raising of the Mary Rose: Archaeology and Salvage Combined", Underwater Archaeology Vol. 21(1) pp. 29–35 / Society for Underwater Technology & Hamel A.T., "Wrecks at Sea: Research in Context".
- 7 Holt P., 1996, "Positioning of Site 'Mary Rose'" – Positioning Survey Report, internal report for the Mary Rose Trust.
- 8 Holt P., 2005, "The application of the Fusion Positioning System to Marine Archaeology", in Tuncay A., Ballard R. D. and Bass G.F., (eds.). The application of recent advances in underwater detection and survey techniques to underwater archaeology, Bodrum.
- 9 Holt P., 2003, "An assessment of quality in underwater archaeological surveys using tape measurements", International Journal of Nautical Archaeology, 32.2, pp 246–251.
- 10 Rule N., 1989, "The Direct Survey Method (DSM) of Underwater Survey and its Application Underwater", International Journal of Nautical Archaeology and Underwater Exploration 18(2) pp. 157–162.
- 11 Hildred A. (Ed.), 2011, "Weapons of Warre, The Archaeology of the Mary Rose" Volume 3 Part 4, Mary Rose Trust Ltd., Portsmouth, ISBN 978-0-9544029-3-8.
- 12 IMCA, 2009, "Deep Water Acoustic Positioning", IMCA M 200 (or IMCA S 013), October 2009
- 13 Warren D., 2004, "ROV Investigations of the DKM U-166 Shipwreck Site to Document the Archaeological and Biological Aspects of the Wreck Site", Final Performance Report, C&C Technologies, Lafayette.
- 14 Wessex Archaeology, 2006, "Wrecks on the Seabed R2: Assessment, Evaluation and Recording", for ALSF Ref: 57453.04, Wessex Archaeology.
- 15 Conte G. et. al, 2007, "Data Gathering in Underwater Archaeology by Means of a Remotely Operated Vehicle", XXI International CIPA Symposium, 01–06 Oct, Athens.

Glossary

Array	A pattern of transponders deployed on the seabed.
Compatt	Computing and Telemetry Transponder.
Control point	A reference point for making survey measurements from.
DGPS	Differential Global Positioning System.
GIS	Geographic Information System.
GPS	Global Positioning System.
HP	Hewlett Packard.
LBL	Long BaseLine.
Rangemeter	A diver operated acoustic transceiver developed by Sonardyne.
ROV	Remotely Operated Vehicle.
RovNav	Sonardyne ROV Navigation transceiver.
Telemetry	Electronic messaging.
Transceiver	Acoustic interrogator and receiver connected to a control system by wires.
Transponder	A self-contained acoustic receiver and transmitter that responds to coded acoustic signals from a transceiver.
Trilateration	Calculation of position using distance measurements.
Trisponder	A range-range electromagnetic positioning system superseded by GPS.
USBL	Ultra Short BaseLine.
UTM	Universe Transverse Mercator.

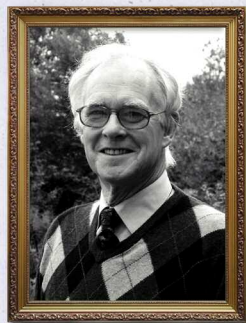

After gaining a BSc in Physics at Bristol University and MSc in Geology/Geophysics at Imperial College with an active involvement in sub-aqua diving, Nigel started his 'Offshore' career as a Marine Geophysicist in the mid-sixties. His career developed during periods as a research marine geophysicist at the UK Institute of Underwater Science and at the research arm of British Petroleum, where he became involved with underwater acoustic positioning in support of oil field development. Nigel joined Sonardyne in 1980 becoming Operations Director where he was Project Manager of many of the company's major international underwater positioning projects until he retired in 2006.

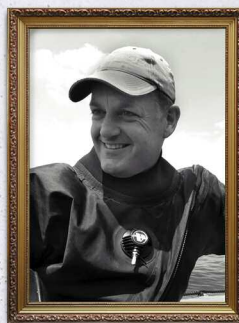

Peter Holt is based in Plymouth where he currently runs maritime archaeology projects for the US charity foundation ProMar. He spent 20 years in the oil industry with Sonardyne designing underwater positioning systems for ROVs and divers. Peter has worked on maritime archaeology projects since 1989 in many countries in water depths down to 1200m. In 1998 he started 3H Consulting Ltd., a maritime archaeology consultancy company and manages The SHIPS Project, which aims to record and investigate the maritime history of Plymouth, England. Peter is a visiting research fellow at Plymouth University, is a NAS Senior Tutor and is on the International Shipwreck Conference organising committee.
